



# USER'S MANUAL

## Programmable Controller Option Board

Models 3G3MV-P10CDT-E  
and 3G3MV-P10CDT3-E

(For SYSDRIVE 3G3MV Multi-function Compact Inverters)



# **3G3MV-P10CDT PLC Option Unit**

## **User's Manual**

*Revised June 2003*

## **Notice:**

OMRON products are manufactured for use according to proper procedures by a qualified operator and only for the purposes described in this manual.

The following conventions are used to indicate and classify precautions in this manual. Always consult the information provided with them. Failure to heed precautions can result in injury to people or damage to the product.



### **DANGER**

Indicates an imminently hazardous situation which, if not avoided, will result in death or serious injury.



### **WARNING**

Indicates a potentially hazardous situation which, if not avoided, could result in death or serious injury.



### **Caution**

Indicates a potentially hazardous situation which, if not avoided, may result in minor or moderate injury, or property damage.

## **OMRON Product References**

All OMRON products are capitalised in this manual. The word “Unit” is also capitalised when it refers to an OMRON product, regardless of whether or not it appears in the proper name of the product.

The abbreviation “Ch,” which appears in some displays and on some OMRON products, often means “word” and is abbreviated “Wd” in documentation in this sense.

The abbreviation “PLC” means Programmable Controller and is not used as an abbreviation for anything else.

## **Visual Aids**

The following headings appear in the left column of the manual to help you locate different types of information.

**Note** Indicates information of particular interest for efficient and convenient operation of the product.

**1, 2, 3...** 1. Indicates lists of one sort or another, such as procedures, checklists, etc.

## **© OMRON, 2003**

All rights reserved. No part of this publication may be reproduced, stored in a retrieval system, or transmitted, in any form, or by any means, mechanical, electronic, photocopying, recording, or otherwise, without the prior written permission of OMRON.

No patent liability is assumed with respect to the use of the information contained herein. Moreover, because OMRON is constantly striving to improve its high-quality products, the information contained in this manual is subject to change without notice. Every precaution has been taken in the preparation of this manual. Nevertheless, OMRON assumes no responsibility for errors or omissions. Neither is any liability assumed for damages resulting from the use of the information contained in this publication.

# TABLE OF CONTENTS

<b>PRECAUTIONS .....</b>	<b>viii</b>
1 Intended Audience.....	ix
2 General Precautions.....	ix
3 Safety Precautions.....	x
4 Maintenance and Inspection Precautions .....	xi
5 Operation and Adjustment Precautions.....	xi
6 Wiring Precautions.....	xii
7 Application Precautions .....	xii
8 EC Directives .....	xiv
<b>SECTION 1</b>	
<b>INTRODUCTION .....</b>	<b>1</b>
1-1 3G3MV-P10CDT Features and Functions .....	2
1-2 System Configurations .....	5
1-3 3G3MV-P10CDT Structure and Operation.....	6
1-4 Comparison with the CPM2C-S.....	10
1-5 Preparation for Operation .....	16
<b>SECTION 2</b>	
<b>UNIT COMPONENTS AND SPECIFICATIONS .....</b>	<b>17</b>
2-1 Specifications .....	18
2-2 Unit Components.....	26
<b>SECTION 3</b>	
<b>INSTALLATION AND WIRING .....</b>	<b>31</b>
3-1 Installation.....	32
3-2 Wiring.....	35
3-3 Connecting I/O Devices .....	35
3-4 Wiring Communication Cables .....	37
3-5 Programming Device Connections.....	37
<b>SECTION 4</b>	
<b>COMMUNICATION, COUNTER AND PULSE .....</b>	<b>38</b>
4-1 PLC-setup Communication .....	39
4-2 High-speed Counters .....	42
4-3 Input Interrupts In Counter Mode.....	45
4-4 Pulse Output Functions.....	48
<b>SECTION 5</b>	
<b>INVERTER INTERFACE.....</b>	<b>56</b>
5-1 Inverter interface .....	57
5-2 I/O Allocation IR.....	57
5-3 I/O Allocation DM .....	60
5-4 Transfer command.....	61
<b>APPENDIX A</b>	
<b>INSTRUCTIONS .....</b>	<b>69</b>

**APPENDIX B**

**EXAMPLE PROGRAMS.....71**

B-1 Basic RUN template program ..... 71  
B-2 Basic Writing Parameter template program ..... 71  
B-3 Basic Read Parameter template program ..... 76  
B-4 Basic Positioning template program ..... 79

**REVISION HISTORY.....97**

## About this Manual:

The 3G3MV-P10CDT is a high-speed Programmable Controller (PLC) with a build-in 3G3MV Inverter interface. There are two manuals describing the setup and operation of the 3G3MV-P10CDT: The *3G3MV-P10CDT Operation Manual* (this manual) and the *CPM1/ CPM1A/CPM2A/CPM2C/SRM1(-V2) Programming Manual* (W353). (The *CPM1/CPM1A/CPM2A/ CPM2C/SRM1(-V2) Programming Manual* is referred to as simply the *Programming Manual* in this manual.) This manual describes the system configuration and installation of the 3G3MV-P10CDT and provides a basic explanation of operating procedures for the Programming Consoles. Read this manual first to acquaint yourself with the 3G3MV-P10CDT.

Refer to the *SYSDRIVE 3G3MV Multi-function Compact Inverter User's Manual* for descriptions of the specifications and installation of the 3G3MV Inverters.

The *SYSMAC Support Software Operation Manuals: Basics and C-series PLCs* (W247 and W248) provide descriptions of SSS operations for the 3G3MV-P10CDT and other SYSMAC C-series PLCs. The *SYS-MAC-CPT Support Software Quick Start Guide* (W332) and *User Manual* (W333) provide descriptions of ladder diagram operations in the Windows environment. The *CX-Programmer User Manual* (W361) and the *CX-Server User Manual* (W362) provide details of operations for the WS02-CXPC1-E CX-Programmer.

Please read this manual carefully and be sure you understand the information provided before attempting to install and operate the 3G3MV-P10CDT.

**Section 1** describes the special features and functions of the 3G3MV-P10CDT, shows the possible system configurations, and outlines the steps required before operation. Read this section first when using the 3G3MV-P10CDT for the first time.

**Section 2** provides the technical specifications of the 3G3MV-P10CDT and describes the main components of these Units.

**Section 3** provides information on installing and wiring a 3G3MV-P10CDT. Be sure to follow the directions and precautions in this section when installing the 3G3MV-P10CDT in a panel or cabinet, wiring the power supply, or wiring I/O.

**Section 4** describes the PLC setup for the communication ports, the counter and pulse-output functionality

**Section 5** explains the interface with the 3G3MV Inverter

**Appendix A** provides the instruction set.

**Appendix B** provides examples.



### WARNING

Failure to read and understand the information provided in this manual may result in personal injury or death, damage to the product, or product failure. Please read each section in its entirety, and be sure you understand the information provided in the section and related sections before attempting any of the procedures or operations given.

# PRECAUTIONS

This section provides general precautions for using the Programmable Controller (PLC) and related devices.

**The information contained in this section is important for the safe and reliable application of the Programmable Controller. You must read this section and understand the information contained before attempting to set up or operate a PLC system.**

1	Intended Audience.....	ix
2	General Precautions.....	ix
3	Safety Precautions.....	x
4	Maintenance and Inspection Precautions.....	xi
5	Operation and Adjustment Precautions.....	xi
6	Wiring Precautions.....	xii
7	Application Precautions.....	xii
8	EC Directives.....	xiv

## 1 Intended Audience

This manual is intended for the following personnel, who must also have knowledge of electrical systems (an electrical engineer or the equivalent).

- Personnel in charge of installing FA systems.
- Personnel in charge of designing FA systems.
- Personnel in charge of managing FA systems and facilities.

## 2 General Precautions

The user must operate the product according to the performance specifications described in the operation manuals.

Before using the product under conditions which are not described in the manual or applying the product to nuclear control systems, railroad systems, aviation systems, vehicles, combustion systems, medical equipment, amusement machines, safety equipment, and other systems, machines and equipment that may have a serious influence on lives and property if used improperly, consult your OMRON representative.

Make sure that the ratings and performance characteristics of the product are sufficient for the systems, machines, and equipment, and be sure to provide the systems, machines, and equipment with double safety mechanisms.

This manual provides information for installing and operating OMRON 3G3MV Inverter PLC Option Units. Be sure to read this manual before operation and keep this manual close at hand for reference during operation.

 **WARNING** It is extremely important that a PLC, and all PLC Units, be used for the specified purpose and under the specified conditions, especially in applications that can directly or indirectly affect human life. You must consult with your OMRON representative before applying a PLC system to the above mentioned applications.

Observe the following precautions when using the SYSDRIVE Inverters and peripheral devices.

This manual may include illustrations of the product with protective covers removed in order to describe the components of the product in detail. Make sure that these protective covers are on the product before use.

Consult your OMRON representative when using the product after a long period of storage.

 **WARNING** Do not touch the inside of the Inverter. Doing so may result in electrical shock.

 **WARNING** Operation, maintenance, or inspection must be performed after turning OFF the power supply, confirming that the CHARGE indicator (or status indicators) are OFF, and after waiting for the time specified on the front cover. Not doing so may result in electrical shock.

 **WARNING** Do not damage, pull on, apply stress to, place heavy objects on, or pinch the cables. Doing so may result in electrical shock.

 **WARNING** Do not touch the rotating parts of the motor under operation. Doing so may

result in injury.

 **WARNING** Do not modify the product. Doing so may result in injury or damage to the product.

 **Caution** Do not store, install, or operate the product in the following places. Doing so may result in electrical shock, fire or damage to the product.

- Locations subject to direct sunlight.
- Locations subject to temperatures or humidity outside the range specified in the specifications.
- Locations subject to condensation as the result of severe changes in temperature.
- Locations subject to corrosive or flammable gases.
- Locations subject to exposure to combustibles.
- Locations subject to dust (especially iron dust) or salts.
- Locations subject to exposure to water, oil, or chemicals.
- Locations subject to shock or vibration.

 **Caution** Do not touch the Inverter radiator, regenerative resistor, or Servomotor while the power is being supplied or soon after the power is turned OFF. Doing so may result in a skin burn due to the hot surface.

 **Caution** Do not conduct a dielectric strength test on any part of the Inverter. Doing so may result in damage to the product or malfunction.

 **Caution** Take appropriate and sufficient countermeasures when installing systems in the following locations. Not doing so may result in equipment damage.

- Locations subject to static electricity or other forms of noise.
- Locations subject to strong electromagnetic fields and magnetic fields.
- Locations subject to possible exposure to radioactivity.
- Locations close to power supplies.

### 3 Safety Precautions

 **WARNING** The Unit refreshes I/O even when the program is stopped (i.e., even in PROGRAM mode). Confirm safety thoroughly in advance before changing the status of any part of memory allocated to I/O or the Inverter. Any changes to the data allocated to any of these may result in unexpected operation of the loads connected to the Unit or Inverter. Any of the following operation may result in changes to memory status.





- Transferring I/O memory data from a Programming Device to the Unit.
- Changing present values in memory with a Programming Device.
- Force-setting/-resetting bits with a Programming Device.
- Transferring I/O memory from a host computer or from another PLC on a network.

 **WARNING** Do not attempt to take any Unit apart while the power is being supplied. Doing so may result in electric shock.







---

## **PRECAUTIONS**



---

-  **WARNING** Do not touch any of the terminals or terminal blocks while the power is being supplied. Doing so may result in electric shock.
-  **WARNING** Do not attempt to disassemble, repair, or modify any Units. Any attempt to do so may result in malfunction, fire, or electric shock.
-  **Caution** Execute online edit only after confirming that no adverse effects will be caused by extending the cycle time. Otherwise, the input signals may not be readable.
-  **Caution** Confirm safety at the destination node before transferring a program to another node or changing contents of the I/O memory area. Doing either of these without confirming safety may result in injury.

### **4 Maintenance and Inspection Precautions**

-  **WARNING** Do not touch the Inverter terminals while the power is being supplied.
-  **WARNING** Maintenance or inspection must be performed only after turning OFF the power supply, confirming that the CHARGE indicator (or status indicators) is turned OFF, and after waiting for the time specified on the front cover. Not doing so may result in electrical shock.
-  **WARNING** Maintenance, inspection, or parts replacement must be performed by authorized personnel. Not doing so may result in electrical shock or injury.
-  **WARNING** Do not attempt to take the Unit apart or repair. Doing either of these may result in electrical shock or injury.
-  **Caution** Carefully handle the Inverter because it uses semiconductor elements. Careless handling may result in malfunction.
-  **Caution** Do not change wiring, disconnect connectors or Operator, or replace fans while power is being supplied. Doing so may result in injury or malfunction.
-  **Caution** Be sure to wire correctly and securely. Not doing so may result in injury or damage to the product.

### **5 Operation and Adjustment Precautions**

-  **WARNING** Turn ON the input power supply only after mounting the front cover, terminal covers, bottom cover, Operator, and optional items. Not doing so may result in electrical shock.
-  **WARNING** Do not remove the front cover, terminal covers, bottom cover, Operator, or optional items while the power is being supplied. Not doing so may result in electrical shock.
-  **WARNING** Do not operate the Operator or switches with wet hands. Doing so may result in electrical shock.

 **WARNING** Do not touch the inside of the Inverter. Doing so may result in electrical shock.

 **WARNING** Provide a separate emergency stop switch because the STOP Key on the Operator is valid only when function settings are performed. Not doing so may result in injury.

## 6 Wiring Precautions

 **WARNING** Wiring must be performed only after confirming that the power supply has been turned OFF. Not doing so may result in electrical shock.

 **WARNING** Wiring must be performed by authorized personnel. Not doing so may result in electrical shock or fire.

## 7 Application Precautions

Observe the following precautions when using the PLC Unit.

 **WARNING** Failure to abide by the following precautions could lead to serious or possibly fatal injury. Always heed these precautions.

- Always ground the system with 100  $\Omega$  or less when installing the system, to protect against electrical shock.
- Always turn off the power supply to the PLC before attempting any of the following. Performing any of the following with the power supply turned on may lead to electrical shock:
  - Assembling any devices or racks.
  - Connecting or disconnecting any connectors, cables or wiring.
  - Setting DIP switches or rotary switches.

 **WARNING** Failure to abide by the following precautions could lead to faulty operation of the PLC or the system, or could damage the PLC or PLC Units. Always heed these precautions.

- Fail-safe measures must be taken by the customer to ensure safety in the event of incorrect, missing, or abnormal signals caused by broken signal lines, momentary power interruptions, or other causes.
- Interlock circuits, limit circuits, and similar safety measures in external circuits (i.e., not in the Programmable Controller) must be provided by the customer.
- Use the Units only with the power supplies and voltages specified in the operation manuals. Other power supplies and voltages may damage the Units.
- Take appropriate measures to ensure that the specified power with the rated voltage and frequency is supplied. Be particularly careful in places where the power supply is unstable. An incorrect power supply may result in malfunction.
- Install external breakers and take other safety measures against short-circuiting in external wiring. Insufficient safety measures against short-circuiting may result in burning.
- Do not apply voltages exceeding the rated input voltage to Input Units. The

---

## PRECAUTIONS

---

Input Units may be destroyed.

- Do not apply voltages exceeding the maximum switching capacity to Output Units. The Output Units may be destroyed.



### Caution

- Install the Units properly as specified in the operation manuals. Improper installation of the Units may result in malfunction.
- Wire all connections correctly. Double-check all wiring and switch settings before turning on the power supply. Incorrect wiring may result in burning.
- Mount Units only after checking terminal blocks and connectors completely.
- Be sure that the terminal blocks, Memory Units, expansion cables, and other items with locking devices are properly locked into place. Improper locking may result in malfunction.
- Check switch settings, the contents of the DM Area, and other preparations before starting operation. Starting operation without the proper settings or data may result in an unexpected operation.
- Check the user program for proper execution before actually running it on the Unit. Not checking the program may result in an unexpected operation.
- Confirm that no adverse effect will occur in the system before attempting any of the following. Not doing so may result in an unexpected operation.
  - Changing the operating mode of the PLC.
  - Force-setting/force-resetting any bit in memory.
  - Changing the present value of any word or any set value in memory.
- Resume operation with a new CPU Unit only after transferring the contents of the DM Area, HR Area, and other data required for resuming operation to the new Unit. Not doing so may result in an unexpected operation.
- Do not pull on the cables or bend the cables beyond their natural limit. Doing either of these may break the cables.
- Do not place objects on top of the cables or other wiring lines. Doing so may break the cables.
- Before touching a Unit, be sure to first touch a grounded metallic object in order to discharge any static built-up. Not doing so may result in malfunction or damage.
- Do not touch circuit boards or the components mounted to them with your bare hands. There are sharp leads and other parts on the boards that may cause injury if handled improperly.
- Do not attempt to take any Units apart, to repair any Units, or to modify any Units in any way.

## 8 EC Directives

### 8-1 Applicable Directives

- EMC Directives
- Low Voltage Directive

### 8-2 Concepts

#### EMC Directives

OMRON devices that comply with EC Directives also conform to the related EMC standards so that they can be more easily built into other devices or the overall machine. The actual products have been checked for conformity to EMC standards (see the following note). Whether the products conform to the standards in the system used by the customer, however, must be checked by the customer.

EMC-related performance of the OMRON devices that comply with EC Directives will vary depending on the configuration, wiring, and other conditions of the equipment or control panel on which the OMRON devices are installed. The customer must, therefore, perform the final check to confirm that devices and the overall machine conform to EMC standards.

**Note** Applicable EMC (Electromagnetic Compatibility) standards are as follows:

EMS (Electromagnetic Susceptibility): EN61800-3

EMI (Electromagnetic Interference): EN50081-2/EN55011

(Radiated emission: 10-m regulations)

#### Low Voltage Directive

Safety standard: EN50178: 1997

### 8-3 Conformance to EC Directives

The 3G3MV series products comply with EC Directives. To ensure that the machine or device in which the PLC is used complies with EC Directives, the PLC must be installed as follows:

- 1, 2, 3...**
1. The PLC must be installed within a control panel.
  2. You must use reinforced insulation or double insulation for the DC power supplies used for the communications power supply and I/O power supplies.
  3. OMRON PLCs complying with EC Directives also conform to the Common Emission Standard (EN50081-2). Radiated emission characteristics (10-m regulations) may vary depending on the configuration of the control panel used, other devices connected to the control panel, wiring, and other conditions. You must therefore confirm that the overall machine or equipment complies with EC Directives.

# SECTION 1 Introduction

This section describes the special features and functions of the 3G3MV-P10CDT, shows the possible system configurations, and outlines the steps required before operation. Read this section first when using the 3G3MV-P10CDT for the first time. Refer to the *CPM1/CPM1A/CPM2A/CPM2C/SRM1(-V2) Programming Manual (W353)* for details on programming operations.

1-1	3G3MV-P10CDT Features and Functions .....	2
1-1-1	<i>3G3MV-P10CDT Features</i> .....	2
1-1-2	<i>Overview of 3G3MV-P10CDT Functions</i> .....	4
1-2	System Configurations .....	5
1-2-1	<i>Unit types</i> .....	5
1-3	3G3MV-P10CDT Structure and Operation .....	6
1-3-1	<i>3G3MV-P10CDT Structure</i> .....	6
1-3-2	<i>Operating Modes</i> .....	7
1-3-3	<i>Operating Mode at Startup</i> .....	8
1-3-4	<i>Cyclic Operation and Interrupts</i> .....	9
1-4	Comparison with the CPM2C-S .....	10
1-5	Preparation for Operation .....	16

## 1-1 3G3MV-P10CDT Features and Functions

### 1-1-1 3G3MV-P10CDT Features

The 3G3MV-P10CDT PLC Option Units are compact CPM2C PLCs that have been equipped with a 3G3MV-Inverter interface. The 3G3MV-P10CDT incorporates a variety of special features just like the CPM2C, including synchronized pulse control, interrupt inputs, pulse outputs, and a clock function.

- The Inverter interface reduces wiring, and saves space. Instead of using a CPM2C with CIF11 to communicate to an 3G3MV-Inverter, the P10CDT communicates directly to the Inverter without the overhead.
- The 3G3MV-P10CDT itself can handle a wide range of machine control applications. In addition, the 3G3MV-P10CDT is capable of communications with devices such as personal computers and OMRON Programmable Terminals so it is ideal to use to expand or upgrade existing systems.
- The 3G3MV-P10CDT CPU Unit has a total of 10 I/O points: 6 inputs, 3 transistor outputs and 1 relay output.
- The communications port can be used simultaneously as two ports: Peripheral and RS-232C. The peripheral port supports Programming Devices, Host Link, and no-protocol communications. The RS-232C port supports Host Link, no-protocol (serial), 1:1 PLC Link, and 1:1 NT Link communications.
- Included is also an RS-422/485 interface (not all models) which allows for a cheap connection to other 3G3MV-P10CDT's, other Inverters, NT-terminals, etc.

#### Example System Configuration

A basic standalone application with HMI:

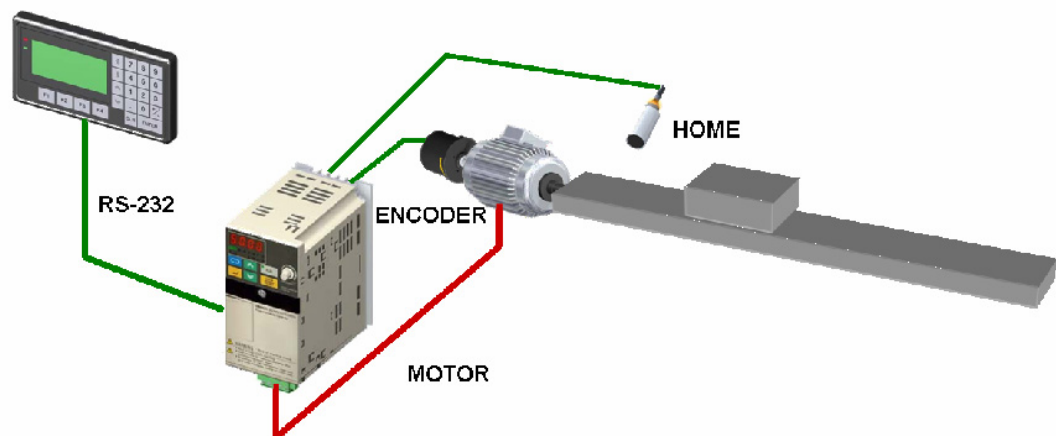

A typical winder application:

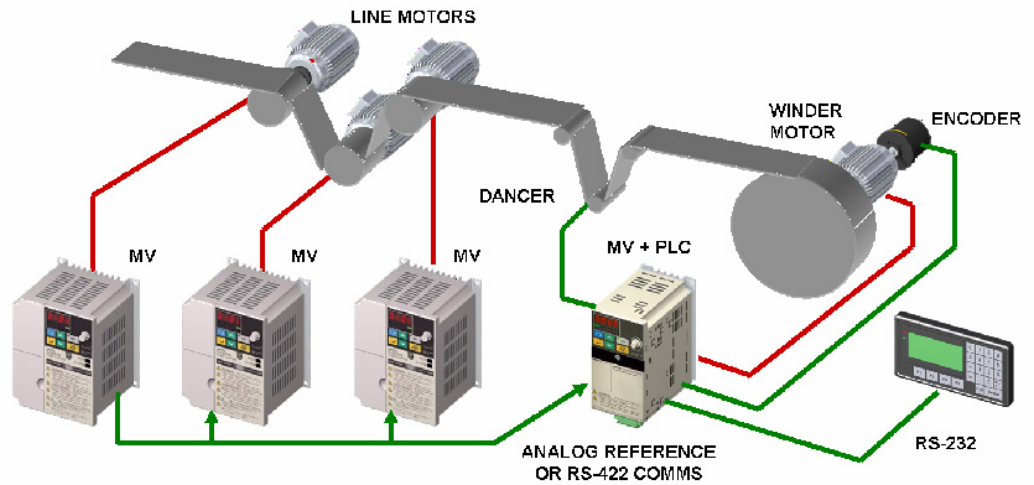

The 3G3MV and PLC Option Unit take care of diameter calculation, dancer PID, user input, etc. The other simply run in speed control. This type of application uses both RS-232C and RS-422 communication.

### Loss of Inverter functionality

Whenever the 3G3MV-P10CDT is attached to a 3G3MV Inverter, the following functionality of the Inverter is lost:

- Modbus communication through the RS-422 interface of the Inverter is disabled. The Modbus communication through the RJ-45 connector is still available.

### Inverter-interface restriction

The following resources have limited control:

- Only one analog input can be read directly. The other input can be read by using the Transfer command in combination with PID with feedback.
- The analog outputs cannot be controlled by the 3G3MV-P10CDT

**Note** Minimum Inverter firmware version requirement: 24

## 1-1-2 Overview of 3G3MV-P10CDT Functions

Main function	Variations/Details	
Inverter interface	Direct interface with 3G3MV Inverter through <ul style="list-style-type: none"> <li>IR-memory</li> <li>DM-memory</li> <li>Transfer command</li> </ul>	
Interrupts	Interrupt inputs 2 inputs Response time: 50 $\mu$ s	
	Interval timer interrupts 1 input Set value: 0.5 to 319,968 ms Precision: 0.1 ms	Scheduled interrupts
		One-shot interrupt
High-speed counters	High-speed counter 1 input, see note 1. Differential phase mode (5 kHz) Pulse plus direction input mode (20 kHz) Up/down input mode (20 kHz) Increment mode (20 kHz)	No interrupt
		Count-check interrupt (An interrupt can be generated when the count equals the set value or the count lies within a preset range.)
	Interrupt inputs (counter mode) 2 inputs Incrementing counter (2 kHz) Decrementing counter (2 kHz)	No interrupt
		Count-up interrupt
Pulse outputs	<ul style="list-style-type: none"> <li>2 outputs: Single-phase pulse output without acceleration/deceleration (See note 2.) 10 Hz to 10 kHz</li> <li>2 outputs: Variable duty ratio pulse output (See note 2.) 0.1 to 999.9 Hz, duty ratio 0 to 100%</li> <li>1 output: Pulse output with trapezoidal acceleration/deceleration (See note 2.) Pulse plus direction output, up/down pulse output, 10 Hz to 10 kHz</li> </ul>	
Synchronized pulse control	1 point, see notes 1 and 2. Input frequency range: 10 to 500 Hz, 20 Hz to 1 kHz, or 300 Hz to 20 kHz Output frequency range: 10 Hz to 10 kHz	
Quick-response input	2 inputs Minimum input signal width: 50 $\mu$ s	
Input time constant	Determines the input time constant for all inputs. (Settings: 1, 2, 3, 5, 10, 20, 40, or 80 ms)	
Calendar/Clock	Shows the current year, month, day of the week, day of the month, hour, minute, and second.	

- Note**
- This input is shared by the high-speed counter and synchronized pulse control functions.
  - This output is shared by the pulse output and synchronized pulse control functions.

## 1-2 System Configurations

### 1-2-1 Unit types

#### 3G3MV-P10CDT Units

Item	3G3MV-P10CDT-E	3G3MV-P10CDT3-E
PLC core	CPM2C-S	CPM2C-S
Inputs	6 24 VDC inputs	6 24 VDC inputs
Outputs	3 sinking transistor outputs	3 sinking transistor outputs
	1 relay output	1 relay output
Peripheral port	Yes	Yes
RS-232C port	Yes	Yes
RS-422/485 port	No	Yes
Calendar/Clock	No	Yes
Memory backup	Flash memory and capacitor	Flash memory and battery

## 1-3 3G3MV-P10CDT Structure and Operation

### 1-3-1 3G3MV-P10CDT Structure

The following diagram shows the internal structure of the Unit.

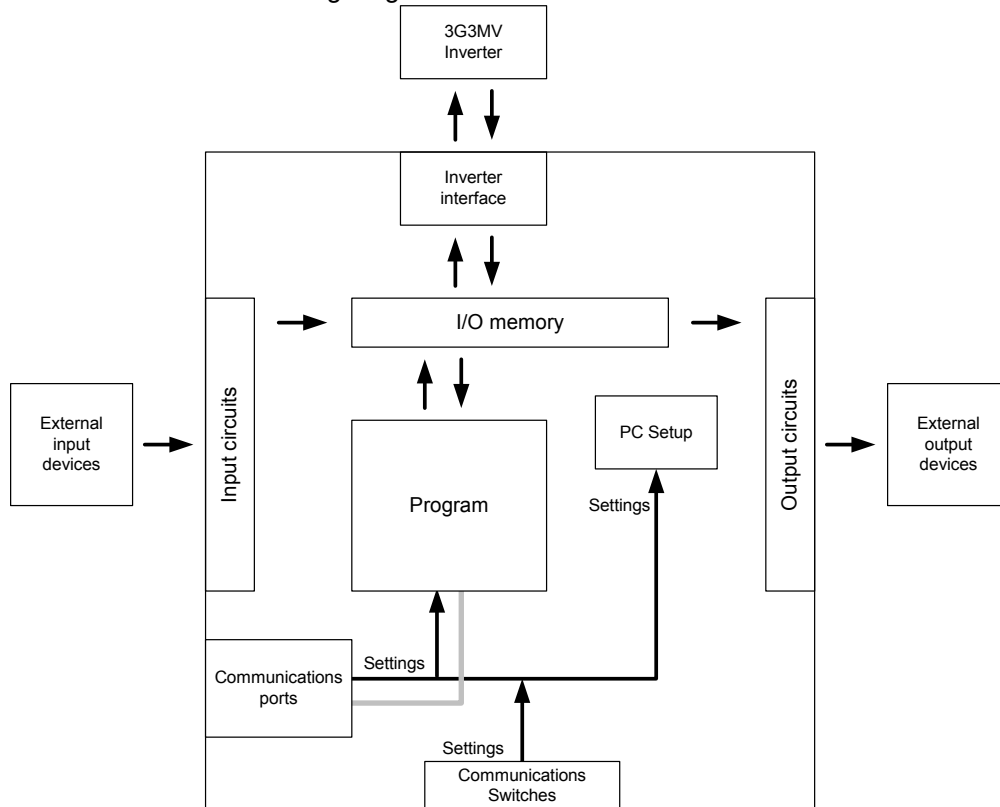

#### I/O Memory

The program reads and writes data in this memory area during execution. Part of the I/O memory contains the bits that reflect the status of the PLC's inputs and outputs. Parts of the I/O memory are cleared when the power is turned ON and other parts are retained.

#### Program

This is the program written by the user. The 3G3MV-P10CDT executes the program cyclically. (Refer to section 1-3-4 *Cyclic Operation and Interrupts* for details.) The program can be divided broadly into two parts: the "main program" that is executed cyclically and the "interrupt programs" that are executed only when the corresponding interrupt is generated.

#### PLC Setup

The PLC Setup contains various startup and operating parameters. The PLC Setup parameters can be changed from a Programming Device only; they cannot be changed from the program.

Some parameters are accessed only when PLC's power supply is turned ON and others are accessed regularly while the power is ON. It will be necessary to turn the power OFF and then ON again to enable a new setting if the parameter is accessed only when the power is turned ON.

**Note** Refer to 4-1 *PLC-setup* for details on the PLC Setup.

#### Communications Switches

The Communications Switches determine whether the peripheral port and RS-232C port connected through the communications port operate with the standard communications settings or the communications settings in the PLC Setup.

#### Inverter Interface

The PLC core communicates to the Inverter through IR-, DM-memory, either by direct mapping or through the Transfer command.

**Note** Refer to section 5-4 *Transfer command* for more details.

## 1-3-2 Operating Modes

3G3MV-P10CDT Units have 3 operating modes: PROGRAM, MONITOR, and RUN.

### PROGRAM Mode

The program cannot be executed in PROGRAM mode. This mode is used to perform the following operations in preparation for program execution.

- Changing initial/operating parameters such as those in the PLC Setup
- Writing, transferring, or checking the program
- Checking wiring by force-setting and force-resetting I/O bits



### Caution

The PLC continues to refresh I/O bits even if the PLC is in PROGRAM mode, so devices connected to output points may operate unexpectedly if the corresponding output bit is turned ON by transferring I/O memory or force-setting output bits from a Programming Device.

### MONITOR Mode

The program is executed in MONITOR mode and the following operations can be performed from a Programming Device. In general, MONITOR mode is used to debug the program, test operation, and make adjustments.

- Online editing
- Monitoring I/O memory during operation
- Force-setting/force-resetting I/O bits, changing set values, and changing present values during operation

### RUN Mode

The program is executed at normal speed in RUN mode. Operations such as online editing, force-setting/force-resetting I/O bits, and changing set values/present values cannot be performed in RUN mode, but the status of I/O bits can be monitored.

### 1-3-3 Operating Mode at Startup

The operating mode of the 3G3MV-P10CDT when the power is turned ON depends upon the setting of pin 2 on the DIP switch on the front of the 3G3MV-P10CDT, the PLC Setup settings in DM 6600, and the Programming Console's mode switch setting if a Programming Console is connected.

PLC Setup setting			Operating mode
Word	Bits	Setting	
DM 6600	08 to 15	00 (Hex)	See note 1.
		01 (Hex)	Startup mode is the same as the operating mode before power was interrupted.
		02 (Hex)	Startup mode is determined by bits 00 to 07.
	00 to 07	00 (Hex)	PROGRAM mode
		01 (Hex)	MONITOR mode
		02 (Hex)	RUN mode

**Note 1.** The operating mode at startup depends upon the setting of DIP switch pin 2 and the Programming Device connected to the communications port (peripheral port).

Programming Device	Pin 2 OFF	Pin 2 ON
None	PROGRAM mode	RUN mode
Programming Console	Operating mode set on the Programming Console's mode switch	
Other device	PROGRAM mode	

The default setting for bits 08 to 15 of DM 6600 is 00. If this default setting is used and pin 2 is OFF, the 3G3MV-P10CDT will automatically start operating in RUN mode when the power is turned ON.

**Note 2.** If pin 2 is OFF and only an RS-232C cable is connected to the communications port (i.e., there is no peripheral port connection), the 3G3MV-P10CDT will automatically start operating in RUN mode when the power is turned ON.

Example Cable Connections:

CS1W-CN118 and XW2Z-200S/500S

CS1W-CN118 and XW2Z-200S-V/500S-V

CPM2C-CN111 and XW2Z-200S/500S (no peripheral port connection)

CPM2C-CN111 and XW2Z-200S-V/500S-V (no peripheral port connection)

### 1-3-4 Cyclic Operation and Interrupts

**Basic CPU Operation**

Initialisation processing is performed when the power is turned on. If there are no initialisation errors, the overseeing processes, program execution, I/O refreshing, and communications port servicing are performed repeatedly (cyclically).

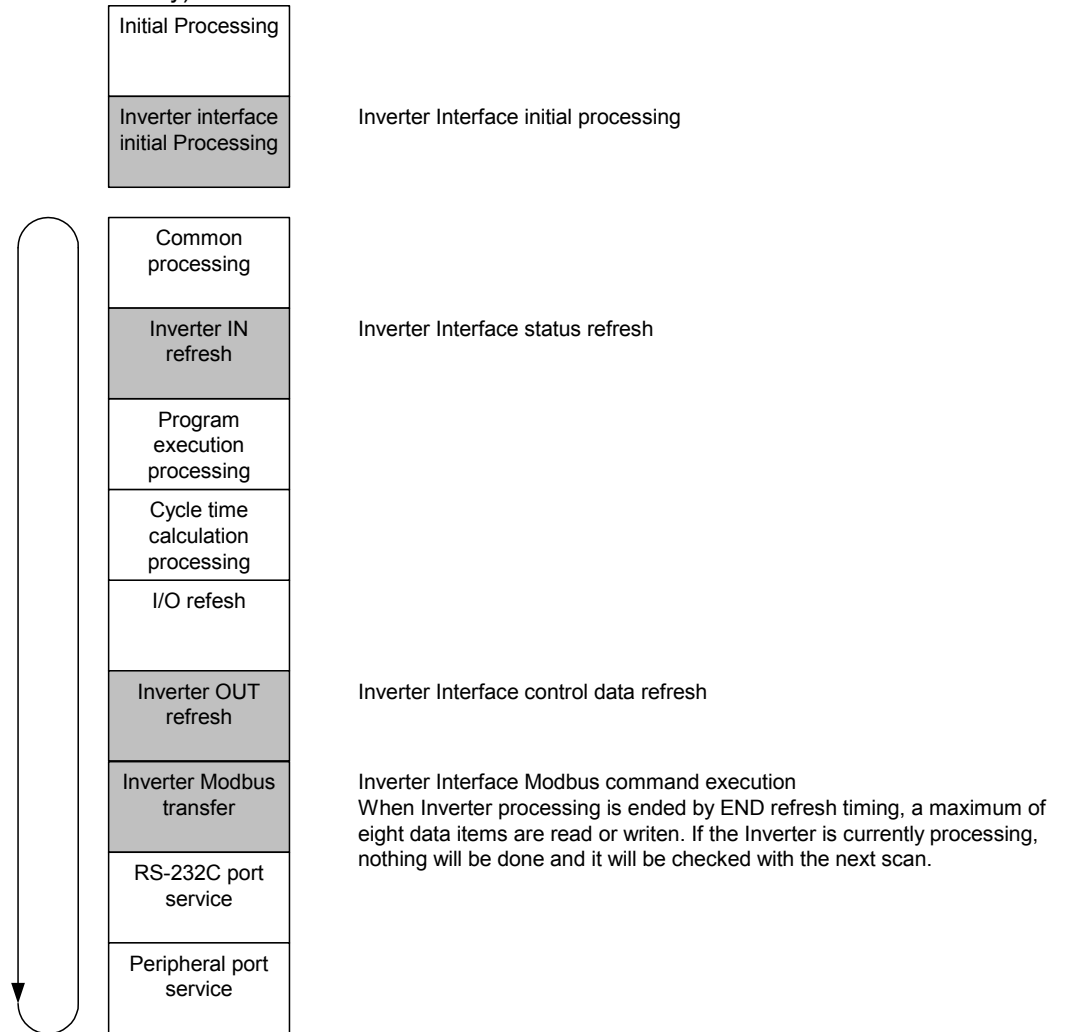

The cycle time can be read from a Programming Device. AR 14 contains the maximum cycle time and AR15 contains the present cycle time in multiples of 0.1 ms.

## 1-4 Comparison with the CPM2C-S

Item		CPM2C-S	3G3MV-P10CDT	
Instruction set	Basic instructions	14	14	
	Special instructions	105 instructions, 185 variations	105 instructions, 185 variations	
Instruction execution times	Basic instructions	LD: 0.64 $\mu$ s	LD: 0.64 $\mu$ s	
	Special instructions	MOV(21): 7.8 $\mu$ s	MOV(21): 7.8 $\mu$ s	
Program capacity		4,096 words	4,096 words	
Maximum number of I/O points	Stand-alone CPU Unit	10 points	10 points	
	CPU Unit with Expansion I/O Units	362 points max.	---	
Expansion Units and Expansion I/O Units	Maximum number of Units	A maximum of 3 Units.	---	
	Available models	Expansion I/O Units, Analog I/O Unit, Temperature Sensor Unit, and CompoBus/S I/O Link Unit	---	
I/O memory	Input bits	IR 00000 to IR 00915	IR 00000 to IR 00005	
	Output bits	IR 01000 to IR 01915	IR 01000 to IR 01003	
I/O memory	Work bits	672 bits: IR 02800 to IR 02915, IR 03800 to IR 04915, IR 20000 to IR 22715	880 bits: IR 00100 to IR 00915, IR 01100 to IR 02815, IR 03000 to IR 04915, IR 22000 to IR 22715	
	SR (Special Relay) area	448 bits: SR 22800 to SR 25515	448 bits: SR 22800 to SR 25515	
	TR (Temporary Relay) area	8 bits: TR0 to TR7	8 bits: TR0 to TR7	
	HR (Holding Relay) area	320 bits: HR 0000 to HR 1915	320 bits: HR 0000 to HR 1915	
	AR (Auxiliary Relay) area	384 bits: AR 0000 to AR 2315	384 bits: AR 0000 to AR 2315	
	LR (Link Relay) area	256 bits: LR 0000 to LR 1515	256 bits: LR 0000 to LR 1515	
	Timer/Counter area	256 bits: TIM/CNT 000 to TIM/CNT 255	256 bits: TIM/CNT 000 to TIM/CNT 255	
	DM (Data Memory) area	Read/write area	2,022 words: DM 0000 to DM 2021	1,993 words: DM 0000 to DM 1985 DM 2041 to DM 2047
		Reserved	---	14 words: DM 1986 to DM 1999
		Read-only area	456 words: DM 6144 to DM 6599	456 words: DM 6144 to DM 6599
		PLC Setup	56 words: DM 6600 to DM 6655	56 words: DM 6600 to DM 6655
Inverter Interface		---	288 bits: IR 20000 to IR 21715 19 words: DM 2022 to DM 2040	

Item		CPM2C-S	3G3MV-P10CDT
Memory backup	Program area, read-only DM area (including PLC Setup)	Flash memory backup	Flash memory backup
	Read/write DM area, HR area, AR area, and counters	Internal battery backup (2-year life-time at 25°C, replaceable)	Unit with clock: Internal battery backup (5-year lifetime at 25°C, non-replaceable)
			Unit without clock: Capacitor backup (10-day backup at 25°C)
CompoBus/S Master Functions		Up to 32 Slaves can be connected and up to 256 I/O points can be controlled.	---
DeviceNet Slave Functions		DeviceNet Remote I/O Link Use up to 1,024 I/O points in the I/O Link. Explicit Message Communications Any PLC data area can be accessed from the Master.	---
Interrupt inputs (interrupt input mode)		2	2
Interrupt inputs (counter mode)	Counter mode	Incrementing counter Decrementing counter	Incrementing counter Decrementing counter
	Counter upper limit	2 kHz	2 kHz
	SR 244 to SR 247	Contains counter PV.	Contains counter PV.
	Method(s) to read counter PV	Read SR 244 to SR247. Execute PRV(62).	Read SR 244 to SR247. Execute PRV(62).
	Method to change counter PV	Execute INI(61).	Execute INI(61).
Interval timer	One-shot mode	Yes	Yes
	Scheduled interrupt mode	Yes	Yes
Quick-response inputs	Setting the quick-response function	PLC Setup	PLC Setup
	INT(89) (Mask)	Not supported (ignored)	Not supported (ignored)
	INT(89) (Read mask)	Reads mask status.	Reads mask status.
	INT(89) (Clear)	Not supported (ignored)	Not supported (ignored)
	Minimum pulse width	50 µs min.	50 µs min.
High-speed counter	Count mode	Differential-phase (up/down) mode Pulse plus direction mode Up/down pulse mode Increment mode	Differential-phase (up/down) mode Pulse plus direction mode Up/down pulse mode Increment mode
	Max. counter frequency	5 kHz in differential-phase (up/down) mode 20 kHz in pulse plus direction mode, up/down pulse mode, and increment mode	5 kHz in differential-phase (up/down) mode 20 kHz in pulse plus direction mode, up/down pulse mode, and increment mode
	Counter PV range	–8,388,608 to 8,388,607 in differential-phase (up/down) mode, pulse plus direction mode, and up/down pulse mode 0 to 16,777,215 in increment mode	–8,388,608 to 8,388,607 in differential-phase (up/down) mode, pulse plus direction mode, and up/down pulse mode 0 to 16,777,215 in increment mode

	<b>Item</b>	<b>CPM2C-S</b>	<b>3G3MV-P10CDT</b>
	Check when registering target value match table	Same direction, same SV not possible	Same direction, same SV not possible

Item		CPM2C-S	3G3MV-P10CDT
High-speed counter (continued)	Method used to reference the target value match interrupt table	Comparison of all values in the table, regardless of order of appearance in table	Comparison of all values in the table, regardless of order of appearance in table
	Reading range-comparison results	Check AR 1100 to AR1107 or execute PRV(62).	Check AR 1100 to AR1107 or execute PRV(62).
	Reading status	Check AR 1108 (comparison in progress), check AR1109 (high-speed counter PV overflow/underflow), or execute PRV(62).	Check AR 1108 (comparison in progress), check AR1109 (high-speed counter PV overflow/underflow), or execute PRV(62).
Pulse synchronization		Supported.	Supported.
Pulse output control	Trapezoidal acceleration/deceleration	Supported with ACC(—). The initial frequency can be set.	Supported with ACC(—). The initial frequency can be set.
	PWM(—) output	Supported.	Supported.
	Number of simultaneous pulse outputs	2 max.	2 max.
	Maximum frequency	10 kHz max.	10 kHz max.
	Minimum frequency	10 Hz	10 Hz
	Pulse output quantity	–16,777,215 to 16,777,215	–16,777,215 to 16,777,215
	Direction control	Supported.	Supported.
	Positioning to absolute positions	Supported.	Supported.
	Bit status while pulses are being output	No effect	No effect
	Reading PV	Read SR 228 through SR231 or execute PRV(62).	Read SR 228 through SR231 or execute PRV(62).
	Resetting PV	Supported.	Supported.
	Status outputs	Accelerating/decelerating PV overflow/underflow Pulse quantity set Pulse output completed Pulse output status	Accelerating/decelerating PV overflow/underflow Pulse quantity set Pulse output completed Pulse output status
Clock function		Internal	Internal or none
	Words containing time info.	AR 17 to AR 21	AR 17 to AR 21
Communications switch		This switch determines whether communications are governed by the standard settings or PLC Setup settings. Also sets the Programming Device connection.	This switch determines whether communications are governed by the standard settings or PLC Setup settings. Also sets the Programming Device connection.
Battery	Battery	Internal lithium battery backup	Unit with clock: Internal lithium battery backup
	Battery replacement	Possible	Not possible
	Life expectancy/ backup time	2-year lifetime at 25°C	Unit with clock: 5-year lifetime at 25°C
	Battery error detection	Supported.	Supported.

Item		CPM2C-S	3G3MV-P10CDT
Communications (in CPU Unit)	Peripheral port (via communications port)	Programming Console (Set with Communications Switch.) Peripheral bus (Set with Communications Switch.) Host Link (with Slave-initiated communications) No-protocol	Programming Console (Set with Communications Switch.) Peripheral bus (Set with Communications Switch.) Host Link (with Slave-initiated communications) No-protocol
	RS-232C port (via communications port)	Peripheral bus (Set with Communications Switch.) Host Link No-protocol 1:1 PLC Link 1:1 NT Link	Peripheral bus (Set with Communications Switch.) Host Link No-protocol 1:1 PLC Link 1:1 NT Link
	RS-422 port	Through CIF-unit	Peripheral bus Host Link (with Slave-initiated communications) No-protocol
Input time constant		Can be set to 1, 2, 3, 5, 10, 20, 40, or 80 ms. (Default: 10 ms)	Can be set to 1, 2, 3, 5, 10, 20, 40, or 80 ms. (Default: 10 ms)

**Differences in I/O Memory****IR Area Differences**

Function	CPM2C-S	3G3MV-P10CDT
CompoBus/S input bits	IR 020 to IR 027	
CompoBus/S output bits	IR 030 to IR 037	
Work bits	672 bits: IR 028 to IR 029 IR 038 to IR 049 IR 200 to IR 227	880 bits: IR 00100 to IR 00915 IR 01100 to IR 02815 IR 03000 to IR 04915 IR 22000 to IR 22715
Inverter Interface		288 bits: IR 20000 to IR 21715

**AR Area Differences**

Function	CPM2C-S	3G3MV-P10CDT
DeviceNet Status	AR 00	
CompoBus/S Active Slave Flags and Communications Error Flags	AR 04 to AR 07	
CompoBus/S Master ASIC Error	AR 1315	

**DM Area Differences**

Function	CPM2C-S	3G3MV-P10CDT
Inverter Interface		19 words: DM 2022 to DM 2040
Reserved		14 words: DM 1986 to DM 1999

**PLC Setup Differences**

Function	CPM2C-S	3G3MV-P10CDT
Maximum number of CompoBus/S nodes	DM 6603 bits 00 to 03	
CompoBus/S communications mode	DM 6603 bits 04 to 07	
DeviceNet Read/Write area (Default or DM 6606 to DM 6609)	DM 6605 bits 00 to 03	
DeviceNet I/O Link Write Area data area	DM 6606 bits 00 to 07	
DeviceNet I/O Link Write Area number of bytes	DM 6606 bits 08 to 15	
DeviceNet I/O Link Write Area starting address	DM 6607 bits 00 to 15	
DeviceNet I/O Link Read Area data area	DM 6608 bits 00 to 07	
DeviceNet I/O Link Read Area number of bytes	DM 6608 bits 08 to 15	
DeviceNet I/O Link Read Area starting address	DM 6609 bits 00 to 15	

## 1-5 Preparation for Operation

- 1, 2, 3... Follow the steps listed below when setting up a 3G3MV-P10CDT system.
1. System Design
    - Select a 3G3MV-P10CDT Unit with the specifications required in the controlled system.
    - Design external fail-safe circuits such as interlock circuits and limit circuits.
  2. Installation
    - Install the Unit on the Inverter
  3. Wiring
    - Wire the Inverter and I/O devices.
    - Connect communications devices if necessary.
    - Connect the Programming Console.
  4. Initial Settings
    - Set the Communications Switches on the front of the CPU Unit, if necessary. (The switches must be set when a device other than the Programming Console is connected or the standard communications settings are not used.)
    - Connect the Programming Console, set the mode switch to PROGRAM mode, and turn ON the Inverter.
    - Check the Unit's LED indicators and the Programming Console's display.
    - Clear the PLC's memory. (All Clear)
    - Make PLC Setup settings.
  5. Create Ladder Program
    - Create a ladder program to control the system.
  6. Write Ladder Program in PLC
    - Write the ladder program in the PLC with the Programming Console or transfer the program to the PLC from the Support Software.
  7. Test Run
    - Check I/O wiring in PROGRAM mode.
    - Check and debug program execution in MONITOR mode.

## SECTION 2 Unit Components and Specifications

This section provides the technical specifications of the 3G3MV-P10CDT Units and describes the main components of these Units.

2-1	Specifications .....	18
2-1-1	General Specifications .....	18
2-1-2	Characteristics .....	18
2-1-3	I/O Specifications .....	21
2-1-3-1	Input Specifications .....	21
2-1-3-2	Output Specifications .....	23
2-1-4	Dimensions .....	25
2-2	Unit Components .....	26
2-2-1	CPU Unit Component Names .....	26
2-2-2	CPU Unit Component Descriptions .....	26

## 2-1 Specifications

### 2-1-1 General Specifications

Item	Specifications
Rated power supply voltage	24 VDC <sup>+10%</sup> / <sub>-15%</sub> (External power supply for I/O)
Vibration resistance	0.15 mm (10-57 Hz) 9.8 m/s <sup>2</sup> (57-150 Hz) In all directions (X, Y, Z)
Ambient operating temperature	-10 to 45 °C
Ambient operating relative humidity	10% to 90% (no condensation)
Ambient storage temperature	-20 to 70 °C
Atmosphere	Must be free from corrosive gas
Power Consumption	2W (Supplied internally)

**Note** The above figure for power consumption includes the power consumption of the Programming Console.

### 2-1-2 Characteristics

Item	Specifications	
Control method	Store program method	
I/O control method	Cyclic scan method	
Programming language	Ladder chart method	
Instruction length	1 step/1 instruction; 1 to 5 words/1 instruction	
Instruction types	Basic	14 types (Same as for Programmable Slaves.)
	Special	105 types, 185 instructions (Same as for Programmable Slaves.)
Processing speed	Basic instructions	0.64 μs (LD)
	Special instructions	7.8 μs (MOV)
Program capacity	4,096 words	
Maximum number of I/O points	10	
Input bits	00000 to 00015 (6 physical inputs)	
Output bits	01000 to 01003 (4 physical outputs)	
Area allocated to Inverter	320 bits: 20000 to 21915	
IR Area	880 bits: IR 00100 to IR 00915 (words IR 001 to IR 009), IR 01100 to IR 02815 (words IR 011 to IR 028), IR 03000 to IR 04915 (words IR 030 to IR 049), IR 22000 to IR 22715 (words IR 220 to IR 227)	
SR Area	448 bits: SR 22800 to SR 25507 (words SR 228 to SR 255)	
TR Area	8 bits (TR 0 to TR 7)	
HR Area	320 bits: HR 0000 to HR 1915 (words HR 00 to 19)	
AR Area	384 bits: AR 0000 AR 2315 (words AR 00 to AR 23)	
LR Area	256 bits: LR 0000 to LR 1515 (words LR 00 to LR 15)	
Timer/Counter Area	256 bits: TC 000 to TC 255	
DM Area	Read/Write	2029 words (DM 0000 to DM 0999, DM 1019 to DM 2047) DM 2000 to DM 2021: Error Log Storage Area
	Read only	456 words (DM6144 to 6599)

Item		Specifications
	Allocated to Inverter	19 words (DM 2022 to DM 2040)
	PLC Setup	56 words (DM 6599 to DM 6655)

Item		Specifications
Interrupt processing	External interrupts	2 bits (Used in common for input interrupt counter mode and high-speed inputs.)
	Scheduled interrupts	1 bit (Scheduled interrupts or one-shot interrupts)
Pulse outputs		2 bits (without acceleration/deceleration; 10 Hz to 10 kHz each; without directional control). Or 1 bit (with trapezoidal acceleration/deceleration; 10 Hz to 10 kHz each; with directional control). Or 2 bits (Variable duty ratio output).
Pulse synchronous control		1 bit A high-speed counter can be combined with pulse output, and the input pulse frequency from the high-speed counter can be multiplied by a fixed factor for pulse output.
Pulse catch inputs		2 bits Minimum pulse input: 50 µs max. Used in common by input interrupts and input interrupt counter mode.
Analog volume		None
Input time constant (ON response time = OFF response time)		Only all inputs can be set. (1 ms / 2 ms / 3 ms / 5 ms / 10 ms / 20 ms / 40 ms / 80 ms)
Clock function		Yes
Communication function		Port 1 = Peripheral and RS-422 Host Link, Peripheral bus, No-protocol, Programming Console Port 2 = RS-232C port: Host Link, no-protocol, 1:1 PLC Link, 1:1 NT Link
Power-interruption hold function		Holds the contents of HR, AR, CNT, and DM Areas.
Memory backup		Non-volatile memory, User program, DM (Read only), PLC Setup Fixed internal lithium battery (5 years, not replaceable by the user) or capacitor DM (Read/Write), HR, SR and CNT Areas
Self-diagnostic function		CPU errors, memory errors, communications errors, setting errors, battery errors
Program check		No END instruction, program errors (regularly checked during operation)
Connected tools	CX-Programmer	After Version 2.1
	Programming Console	C200H-PRO27, CQM1-PRO01
	SSS	PC98 & PC/AT (SYSMAC Support Software, All version)
	Sysdrive Configurator	After version 2

- Note 1.** The DM area, HR area, AR area, and counter values are backed up. If the backup battery or capacitor is discharged, the contents of these areas will be lost and the data values will revert to the defaults.
- 2.** The contents of the program area, read-only DM area (DM6144 to DM6599), and PLC Setup (DM 6600 to DM 6655) are stored in flash memory. The contents of these areas will be read from flash memory the next time the power is turned ON, even if the backup battery or capacitor is discharged. When data has been changed in any of these areas, write the new values to flash memory by switching the 3G3MV-P10CDT to MONITOR or RUN mode, or by turning the power OFF and then ON again.
- 3.** Changes made while in MONITOR mode using, for example, online editing, are written to flash memory in real-time.

### 2-1-3 I/O Specifications

#### 2-1-3-1 Input Specifications

Item	Inputs	Specification
Input voltage	All	24 VDC <sup>+10%</sup> / <sub>-15%</sub>
Input impedance	IN00000 to IN00001	2.7 kΩ
	IN00002 to IN00004	3.9 kΩ
	IN00005	4.7 kΩ
Input current	IN00000 to IN00001	8 mA typical
	IN00002 to IN00004	6 mA typical
	IN00005	5 mA typical
ON voltage/current	IN00000 to IN00001	17 VDC min., 5 mA
	IN00002 to IN00005	14.4 VDC min., 3.5 mA
OFF voltage/current	All	5.0 VDC max., 1.1 mA
ON delay	All	1 to 80 ms max. Default: 10 ms (See note.)
OFF delay	All	1 to 80 ms max. Default: 10 ms (See note.)
Circuit configuration	IN00000 to IN00001	
	IN00002 to IN00004	
	IN00005	

**Note** The input time constant can be set to 1, 2, 3, 5, 10, 20, 40, or 80 ms in the PLC Setup.

**High-speed Counter Inputs**

The following Unit input bits can be used as high-speed counter inputs. The maximum count frequency is 5 kHz in differential phase mode and 20 kHz in the other modes.

Input	Function			
	Differential phase mode	Pulse plus direction input mode	Up/down input mode	Increment mode
IN00000	A-phase pulse input	Pulse input	Increment pulse input	Increment pulse input
IN00001	B-phase pulse input	Direction input	Decrement pulse input	Normal input
IN00002	Z-phase pulse input or hardware reset input (IN00002 can be used as a normal input when it is not used as a high-speed counter input.)			

The minimum pulse widths for inputs IN00000 (A-phase input) and IN00001 (B-phase input) are as follows:

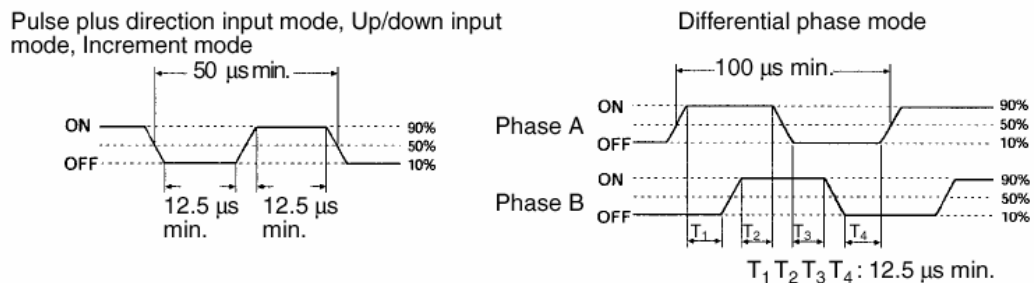

The minimum pulse width for input IN00002 (Z-phase input) is as follows:

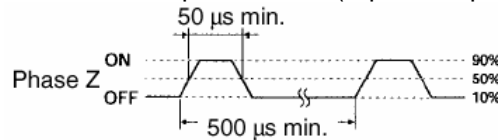

**Interrupt Inputs**

The 3G3MV-P10CDT is equipped with inputs that can be used as interrupt inputs (interrupt input mode or counter mode) and quick-response inputs. The minimum pulse width for these inputs is 50 µs. Inputs IN00003 and IN00004 can be used as interrupt inputs.

2-1-3-2 Output Specifications

Relay Output

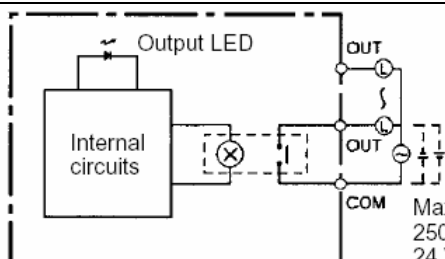
Item	Specification
Maximum switching capacity	2 A, 250 VAC (cos =1) 2A, 24VDC
Minimum switching load	10 mA, 5 VDC
Service life of relay	Electrical: 150,000 operations (24 VDC resistive load) 100,000 operations (240 VAC inductive load cos =0.4) Mechanical: 20,000,000 operations
ON delay	15 ms max.
OFF delay	15 ms max
Circuit configuration	 <p>Maximum 250 VAC: 2 A 24 VDC: 2 A</p>

**Note** The service life of relay output contacts shown in the table assumes the worst conditions. The following graph shows the results of Omron's service life tests at a switching rate of 1,800 times/hour.

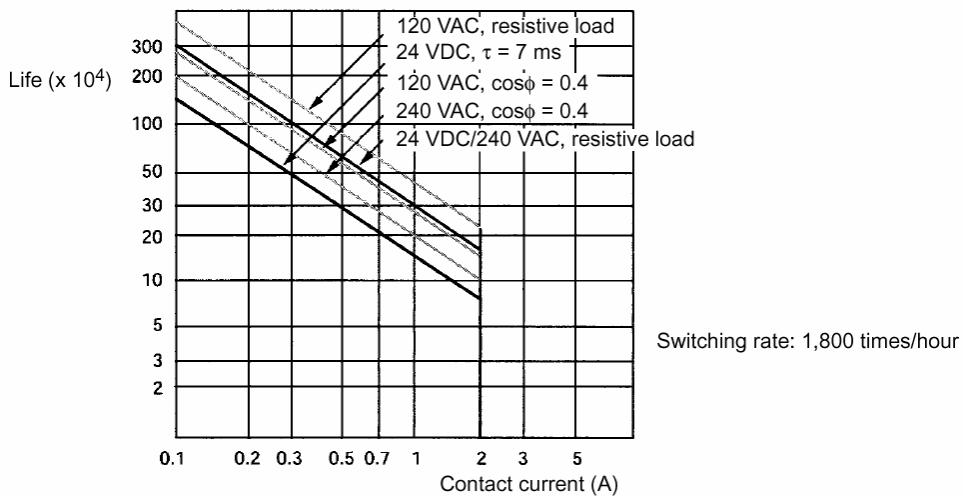

## Transistor Outputs (Sinking)

Item	Specification
Maximum switching capacity	4.5 to 30VDC, 0.2 A/output
Minimum switching capacity	0.5 mA
Maximum inrush current	0.9 A for 10 ms
Leakage current	0.1 mA
Residual voltage	1.5 V max.
ON response time	20 $\mu$ s max.
OFF response time	40 $\mu$ s max. for 4.5 to 26.4 VDC, 10 to 100 mA 0.1 ms max for 4.5 to 30 VDC, 10 to 200 mA
Fuse	One fuse per output (cannot be replaced by user)
Circuit configuration	

**Note 1.** When using OUT01000 or OUT01001 as a pulse output, connect a dummy resistor as required to bring the load current between 0.01 and 0.1 A. If the load current is below 0.1 A, the ON-to-OFF response time will be longer and high-speed pulses (source-type transistor outputs) will not be output. If the load current is above 0.1 A, the transistor will generate more heat and components may be damaged.

 **Caution** Do not apply voltage in excess of the maximum switching capacity to an output terminal. It may result in damage to the product or fire.

**2-1-4 Dimensions**

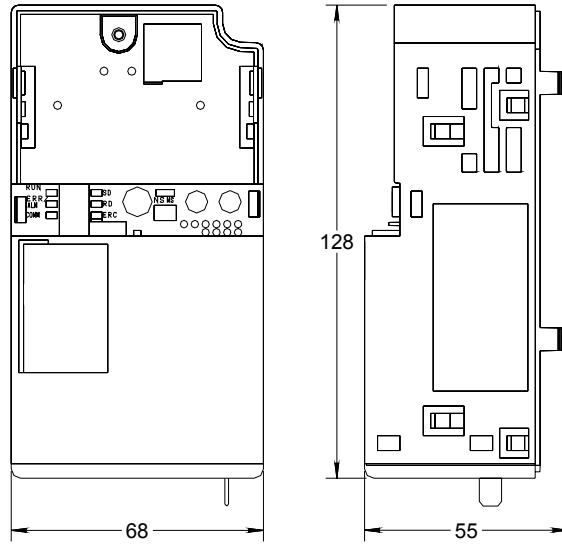

## 2-2 Unit Components

### 2-2-1 CPU Unit Component Names

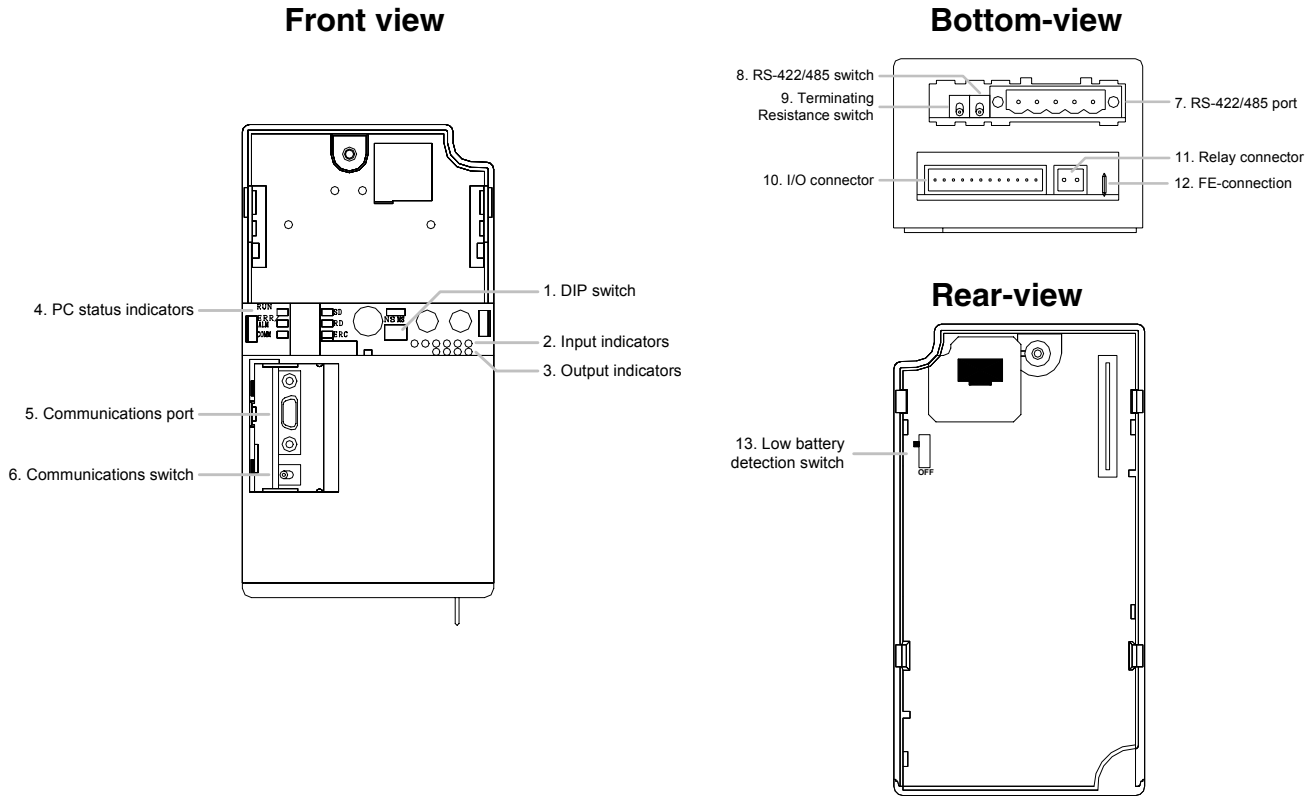

### 2-2-2 CPU Unit Component Descriptions

1,2,3.. 1. DIP switch

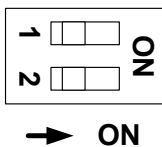

- RS-232C and Peripheral Port Settings

Pin 1	Effective Port Settings
OFF (default)	The ports operate according to the settings in the PLC Setup. RS-232C port settings: DM 6645 to DM 6649 Peripheral port settings: DM 6650 to DM 6654
ON	The ports operate with the standard communications settings.

- Operating Mode at Startup

Pin 2 determines the operating mode at startup only if there isn't a Programming Device connected to the peripheral port.

Programming Device connected	Startup mode with pin 2 OFF (default)	Startup mode with pin 2 ON
None	PROGRAM mode	RUN mode
Programming Console	Operating mode set on the Programming Console's mode switch	
Other device	PROGRAM mode	

2. Input indicators (yellow)

The input indicators are lit when the corresponding input terminal is ON. The status of an input indicator will reflect the status of the input even when that input is being used for a high-speed counter.

**Note a)** When interrupt inputs are used in interrupt input mode, the indicator may not light even when the interrupt condition is met if the input is not ON long enough.

**b)** Input indicators will reflect the status of the corresponding inputs even when the PLC is stopped, but the corresponding input bits will not be refreshed.

3. Output indicators (yellow)

The output indicators are lit when the corresponding output terminal is ON. The indicators are lit during I/O refreshing. The status of an output indicator will also reflect the status of the corresponding output when the output is being used as a pulse output.

4. PLC status indicators

The following indicators show the operating status of the PLC.

Indicator	Status	Meaning
PWR (green)	ON	Power is being supplied to the unit
	OFF	Power isn't being supplied to the unit
RUN (green)	ON	The PLC is operating in RUN or MONITOR mode
	OFF	The PLC is in PROGRAM mode or a fatal error has occurred.
ERR/ALM (red)	ON	A fatal error has occurred. (PLC operation stops.)
	Flashing	A non-fatal error has occurred. (PLC operation continues.)
	OFF	Indicates normal operation.
COMM1 (yellow)	Flashing	Data is being transferred via the peripheral or RS-422/485 port.
	OFF	Data isn't being transferred via communications port.
COMM2 (yellow)	Flashing	Data is being transferred via the RS-232C port
	OFF	Data isn't being transferred via communications port.

5. Communications port

Connects the PLC to a Programming Device (including Programming Consoles), host computer, or standard external device. Use a proper Connecting Cable (CPM2C-CN111, CS1W-CN114, CS1W-CN118, or CS1W-CN226).

**Note a)** A CQM1H-PRO01-E Programming Console can be connected directly to the PLC.

**b)** A C200H-PRO27-E Programming Console can be connected directly to the PLC with a CS1W-CN224/CN624 Connecting Cable.

**c)** Use a CPM2C-CN111 or CS1W-CN114 Connecting Cable to connect to the communications port as a peripheral port. The communications port can be used simultaneously as both a peripheral port and RS-232C port by using the CPM2C-CN111 Connecting Cable.

**d)** Use a CPM2C-CN111, CS1W-CN118 or CS1W-CN226 Connecting Cable to connect to the communications port as a RS-232C port.

The communications port can be used simultaneously as both a peripheral port and RS-232C port by using the CPM2C-CN111 Connecting Cable

**Note** The peripheral port and RS-422/485 port cannot be used simultaneously. When using the peripheral port disconnect any devices connected to the RS-422/485 port.

6. Communications switch

Switch to select port 1 type of connected device

Position	Communication port 1
OFF (default)	Programming Console
ON	RS-422/485 communication

7. RS-422/485 port (3G3MV-P10CDT3-E only)

Used to connect to host computers, or standard external devices.

**Terminal Arrangement**

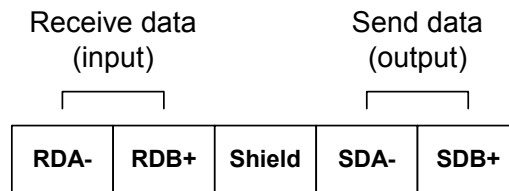

Connector: Phoenix MSTB 2.5/5-STF-5.08AU

**Note** The maximum line length is 500 m.

**Note** The peripheral port and RS-422/485 port cannot be used simultaneously. When using the peripheral port disconnect any devices connected to the RS-422/485 port.

8. RS-422/485 switch (3G3MV-P10CDT3-E only)

Switch to select 4-wire (RS-422) or 2-wire (RS-485) communication

Position	Status
OFF (down) (default)	4-wire communications
ON (up)	2-wire communications

9. Terminating Resistance switch (3G3MV-P10CDT3-E only)

Position	Termination
OFF (down) (default)	Disabled
ON (up)	Enabled

Set this switch to ON only for double-ended connection to a Host Link network.

10. I/O connector

Connects the CPU Unit to external input and output devices.

**Sinking outputs**

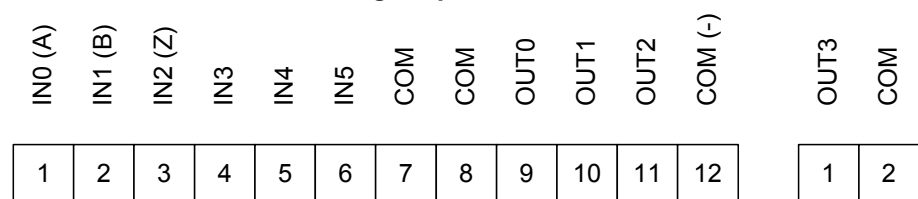

Connector: WAGO 733-112 (wire cross section 0.08 to 0.50 mm<sup>2</sup>)

- 11. Relay connector

Connects the CPU Unit to an external output devices.  
 Connector: WAGO 734-102 (wire cross section 0.08 to 1.50 mm<sup>2</sup>)

- 12. FE-connection

AMP tab to connect functional earth. Internally connected to pin 3 of the RS-422/485 connector and to the shell of the peripheral connector.

- 13. Low battery detection switch (3G3MV-P10CDT3-E only)

This switch enables or disables the detection of a low-battery error.

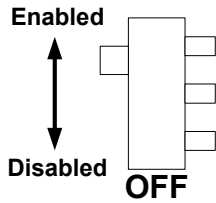

Position	Low-battery detection
ON (up) (default)	Error detection enabled
OFF (down)	Error detection disabled















# SECTION 3 Installation and Wiring

This section provides information on installing and wiring a 3G3MV-P10CDT Unit. Be sure to follow the directions and precautions in this section when installing the 3G3MV-P10CDT in a panel or cabinet and wiring I/O.

- 3-1 Installation .....32
- 3-2 Wiring .....35
- 3-3 Connecting I/O Devices .....35
- 3-4 Wiring Communication Cables .....37
- 3-5 Programming Device Connections .....37

## 3-1 Installation

-  **WARNING** Do not touch the conductive parts such as internal PCBs or terminal blocks while power is being supplied. Doing so may result in electrical shock.
-  **WARNING** Turn ON the input power supply only after mounting the front cover, terminal covers, bottom cover, Operator, and optional items. Leave them mounted in place while power is being supplied. Not doing so may result in electrical shock, malfunction, or damage to the product.
-  **WARNING** Wiring, maintenance, or inspection must be performed by authorized personnel. Not doing so may result in electrical shock or fire.
-  **WARNING** Wiring, maintenance, or inspection must be performed after turning OFF the power supply, confirming that the CHARGE indicator (or status indicators) is OFF, and after waiting for the time specified on the Inverter front cover. Not doing so may result in electrical shock.
-  **WARNING** Do not damage, pull on, apply stress to, place heavy objects on, or pinch the cables. Doing so may result in electrical shock, operation stoppage, or burning.
-  **WARNING** Do not attempt to disassemble or repair the Unit. Doing either of these may result in electrical shock, injury, or damage to the product.
-  **Caution** Do not store, install, or operate the product in the following places. Doing so may result in electrical shock, fire or damage to the product.
- Locations subject to direct sunlight.
  - Locations subject to temperatures or humidity outside the range specified in the specifications.
  - Locations subject to condensation as the result of severe changes in temperature.
  - Locations subject to corrosive or flammable gases.
  - Locations subject to exposure to combustibles.
  - Locations subject to dust (especially iron dust) or salts.
  - Locations subject to exposure to water, oil, or chemicals.
  - Locations subject to shock or vibration.
-  **Caution** Do not allow foreign objects to enter inside the product. Doing so may result in fire or malfunction.
-  **Caution** Do not apply any strong impact. Doing so may result in damage to the product or malfunction.
-  **Caution** Be sure to wire correctly and securely. Not doing so may result in injury or damage to the product.
-  **Caution** Be sure to firmly tighten the screws on the terminal block. Not doing so may result in fire, injury, or damage to the product.
-  **Caution** Carefully handle the product because it uses semiconductor elements. Careless handling may result in malfunction.
-  **Caution** Take appropriate and sufficient countermeasures when installing systems in the following locations. Not doing so may result in equipment damage.
- Locations subject to static electricity or other forms of noise.
  - Locations subject to strong electromagnetic fields and magnetic fields.
  - Locations subject to possible exposure to radioactivity.
  - Locations close to power supplies.

### Mounting Procedure

**Caution** Before installing and wiring an Optional Unit, always turn OFF the power to the SYS-DRIVE 3G3MV Inverter and wait for the CHARGE indicator to turn OFF.

1. Turn OFF the main circuit power supply for the Inverter, wait for at least one minute from the time the LED indicator or the CHARGE indicator goes out, and remove the front cover of the Inverter along with the Operator.

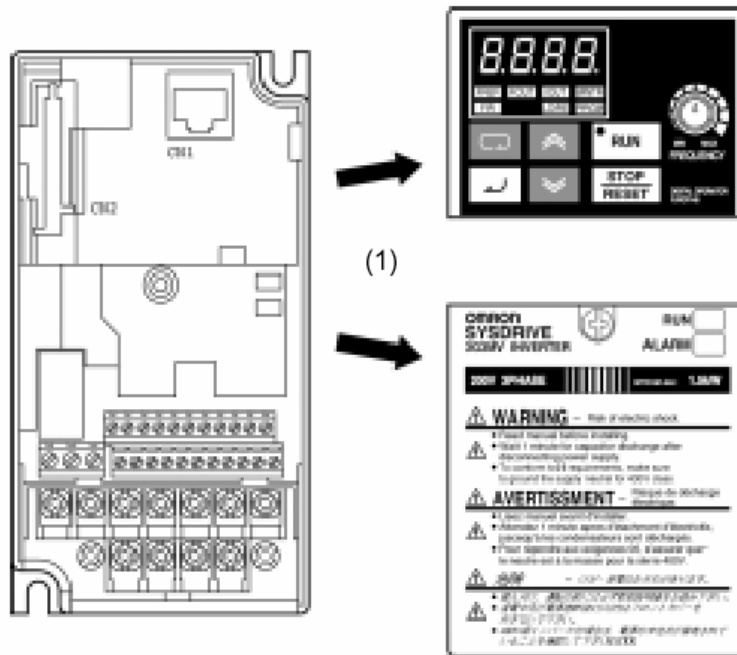

2. Wire the main circuit terminals and control circuit terminals of the Inverter. (When the 3G3MV-P10CDT Unit is mounted, the terminal block of the Inverter will be covered. Therefore, be sure to complete wiring for the Inverter terminals first.)
3. When the Operator of the Inverter is removed, it will be possible to see a block secured at three places underneath. Using pliers or another appropriate tool, loosen the fixings, and remove the block. The connector for Optional Unit connections will become visible. At this point, ensure that dirt or foreign objects do not enter the connector.

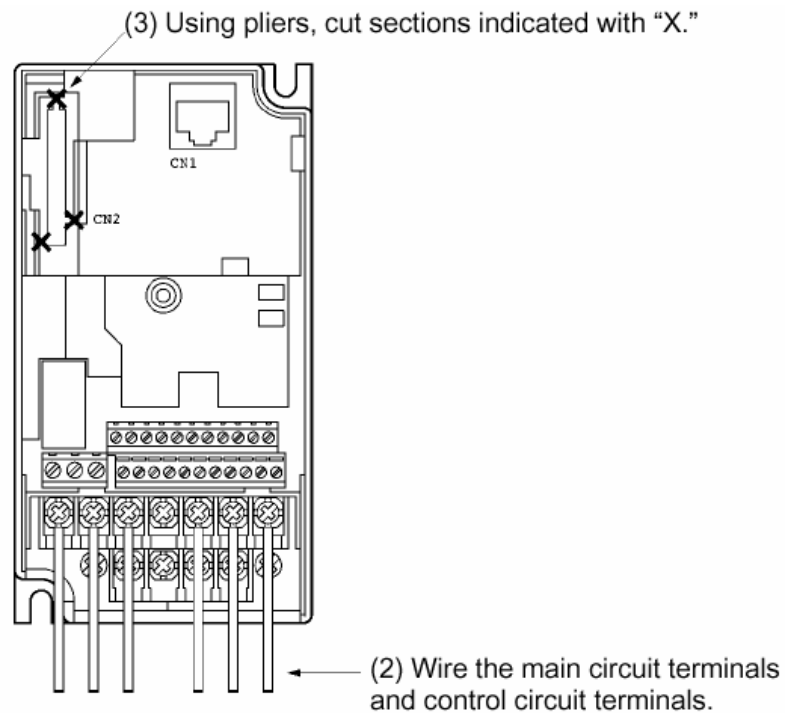

4. Mount the mounting base (included as an accessory) onto the screw-hole originally used for holding the Operator and the terminal cover to the body of the Inverter, and using one of the provided screws, secure the mounting base.

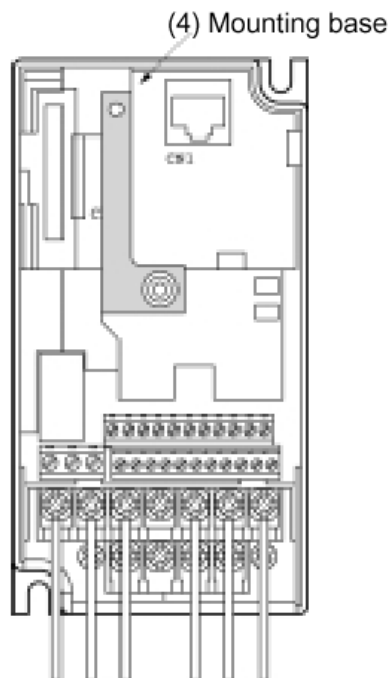

5. After aligning the positions of the PLC Unit connector and the Inverter connector, push the frames of the Inverter and the Unit together until they click.
6. Tighten the fixing screws on the upper part of the PLC Unit, to the mounting base attached in step 4.
7. Attach the Operator and the LED hood to the front side of the PLC Unit. Remove the screw of the Inverter front cover and use it to secure the LED hood and the operator to the Inverter.

## 3-2 Wiring

 **WARNING** Only basic insulation is provided for the control circuit terminals. Additional insulation may be necessary in the end product.

These circuits are not separated from hazardous circuits by protective separation, but only with basic insulation. These circuits cannot be accessed and must not be interconnected with any circuits which are accessible, unless they are isolated from accessible circuits by supplemental insulation. These circuits can be connected only to the following circuits:

30 VDC or less (overvoltage category 2)

250 VAC or less (overvoltage category 2)

## 3-3 Connecting I/O Devices

Wire inputs and outputs to the 3G3MV-P10CDT Unit as shown in the following diagrams.

 **WARNING** The PLC outputs may remain ON or OFF due to deposits on or burning of the output relay or destruction of the output transistors. External safety measures must be provided to ensure safety in the system. Not providing proper safety measures may result in serious accidents.

**Note** When equipment must conform to the EC Directives (Low-voltage Directives), use a power supply with double insulation or reinforced insulation.

 **Caution** Check that wiring has been performed correctly before supplying power. Supplying power with incorrect wiring may result in damage to internal circuits.

### I/O Configuration

The following diagrams show the I/O configurations.

#### **Sinking Transistor Outputs**

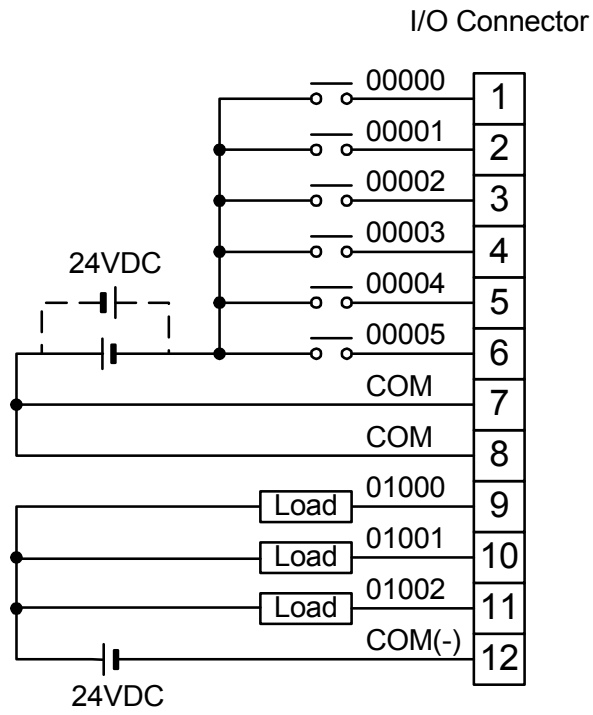

Do not exceed the output capacity or the maximum common current for transistor outputs shown in the following table.

Item	Specification
Output Capacity	200 mA at 24 VDC

**Cage Clamp**

Both the relay and I/O-contractor make use of cage-clamp technology. The picture below shows how the wires should be inserted.

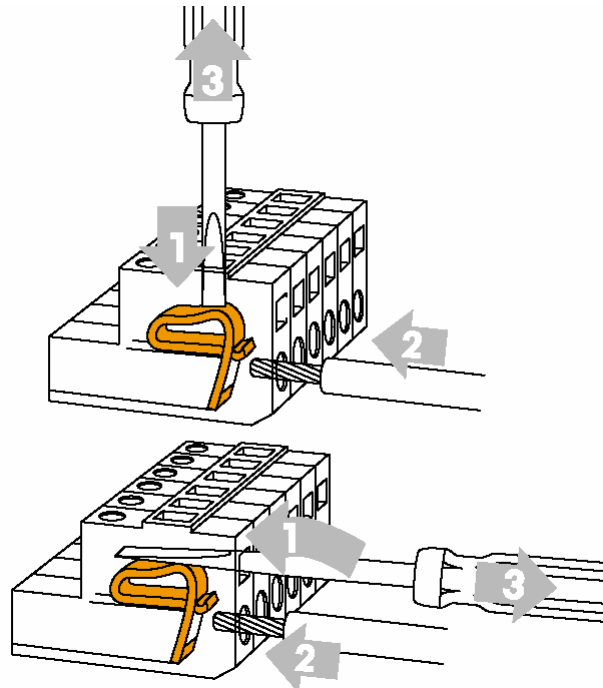

Tools to be used for the I/O connector:

- Perpendicular to the wire (top-half of the picture above)  
Philips screw-driver 2.5 x 0.4 mm
- In-line with the wire (bottom-half of the picture above)  
WAGO tool 233-332

Tools to be used for the relay connector:

- Perpendicular to the wire (top-half of the picture above)  
Philips screw-driver 2.5 x 0.4 mm
- In-line with the wire (bottom-half of the picture above)  
Philips screw-driver 2.5 x 0.4 mm

### 3-4 Wiring Communication Cables

When wiring the RS-422/485 communication cable, make sure to use shielded cable with twisted wires. The shield of the cable can be connected to the middle pin of the RS-422/485 connector. Internally this pin is connected to the Functional Earth tab.

The Functional earth tab is also connected to the shielding of the Peripheral connector.

### 3-5 Programming Device Connections

For a complete overview of Programming Device connections see section 3-4-9 of *W377 Operation Manual CPM2C-S*.

**Note** When using CX-Programmer, select CPM2\*-S\* as PLC Device Type.

## SECTION 4 Communication, Counter and Pulse

This section describes the communication settings and the use of the counter and pulse output functionality of the 3G3MV-P10CDT.

4-1	PLC-setup Communication.....	39
4-1-1	<i>RS-232C Port Communications Settings.....</i>	39
4-1-2	<i>Peripheral RS-422/485 Port Communications Settings.....</i>	40
4-2	High-speed Counters .....	42
4-3	Input Interrupts In Counter Mode.....	45
4-4	Pulse Output Functions.....	48
4-4-1	<i>Using Single-phase Pulse Fixed Duty Ratio .....</i>	49
4-4-2	<i>Using Pulse Outputs With Variable Duty Ratio .....</i>	52
4-4-3	<i>Using Pulse Outputs With Trapezoidal Acceleration/Deceleration.....</i>	53

## 4-1 PLC-setup Communication

### 4-1-1 RS-232C Port Communications Settings

The following settings are effective after transfer to the PLC.  
 If pin 2 of the 3G3MV-P10CDT Unit's DIP switch is ON, communications through the 3G3MV-P10CDT's RS-232C port are governed by the default settings (all 0) regardless of the settings in DM 6645 through DM 6649.

Word(s)	Bit(s)	Function																																																																
DM 6645	00 to 03	Port settings 0: Standard (1 start bit, 7 data bits, even parity, 2 stop bits, 9,600 bps), Host Link unit number: 0 1: Settings in DM 6646 (Any other setting will cause a non-fatal error and AR 1302 will turn ON.)																																																																
	04 to 07	CTS control setting 0: Disable CTS control; 1: Enable CTS control (Any other setting will cause a non-fatal error and AR 1302 will turn ON.)																																																																
	08 to 11	Link words for 1:1 data link 0: LR 00 to LR 15 (Any other settings are ineffective.)																																																																
	12 to 15	Communications mode 0: Host Link; 1: No-protocol; 2: 1:1 PLC Link Slave; 3: 1:1 PLC Link Master; 4: NT Link (Any other setting causes a non-fatal error and turns ON AR 1302.)																																																																
DM 6646	00 to 07	Baud rate 00: 1,200 bps; 01: 2,400 bps; 02: 4,800 bps; 03: 9,600 bps; 04: 19,200 bps																																																																
	08 to 15	Frame format <table style="margin-left: 40px; border-collapse: collapse;"> <thead> <tr> <th></th> <th>Start bits</th> <th>Data bits</th> <th>Stop bits</th> <th>Parity</th> </tr> </thead> <tbody> <tr><td>00:</td><td>1 bit</td><td>7 bits</td><td>1 bit</td><td>Even</td></tr> <tr><td>01:</td><td>1 bit</td><td>7 bits</td><td>1 bit</td><td>Odd</td></tr> <tr><td>02:</td><td>1 bit</td><td>7 bits</td><td>1 bit</td><td>None</td></tr> <tr><td>03:</td><td>1 bit</td><td>7 bits</td><td>2 bits</td><td>Even</td></tr> <tr><td>04:</td><td>1 bit</td><td>7 bits</td><td>2 bits</td><td>Odd</td></tr> <tr><td>05:</td><td>1 bit</td><td>7 bits</td><td>2 bits</td><td>None</td></tr> <tr><td>06:</td><td>1 bit</td><td>8 bits</td><td>1 bit</td><td>Even</td></tr> <tr><td>07:</td><td>1 bit</td><td>8 bits</td><td>1 bit</td><td>Odd</td></tr> <tr><td>08:</td><td>1 bit</td><td>8 bits</td><td>1 bit</td><td>None</td></tr> <tr><td>09:</td><td>1 bit</td><td>8 bits</td><td>2 bits</td><td>Even</td></tr> <tr><td>10:</td><td>1 bit</td><td>8 bits</td><td>2 bits</td><td>Odd</td></tr> <tr><td>11:</td><td>1 bit</td><td>8 bits</td><td>2 bits</td><td>None</td></tr> </tbody> </table> (Any other setting specifies standard settings (1 start bit, 7 data bits; even parity, 2 stop bits, 9,600 bps), causes a non-fatal error, and turns ON AR 1302.)		Start bits	Data bits	Stop bits	Parity	00:	1 bit	7 bits	1 bit	Even	01:	1 bit	7 bits	1 bit	Odd	02:	1 bit	7 bits	1 bit	None	03:	1 bit	7 bits	2 bits	Even	04:	1 bit	7 bits	2 bits	Odd	05:	1 bit	7 bits	2 bits	None	06:	1 bit	8 bits	1 bit	Even	07:	1 bit	8 bits	1 bit	Odd	08:	1 bit	8 bits	1 bit	None	09:	1 bit	8 bits	2 bits	Even	10:	1 bit	8 bits	2 bits	Odd	11:	1 bit	8 bits	2 bits
	Start bits	Data bits	Stop bits	Parity																																																														
00:	1 bit	7 bits	1 bit	Even																																																														
01:	1 bit	7 bits	1 bit	Odd																																																														
02:	1 bit	7 bits	1 bit	None																																																														
03:	1 bit	7 bits	2 bits	Even																																																														
04:	1 bit	7 bits	2 bits	Odd																																																														
05:	1 bit	7 bits	2 bits	None																																																														
06:	1 bit	8 bits	1 bit	Even																																																														
07:	1 bit	8 bits	1 bit	Odd																																																														
08:	1 bit	8 bits	1 bit	None																																																														
09:	1 bit	8 bits	2 bits	Even																																																														
10:	1 bit	8 bits	2 bits	Odd																																																														
11:	1 bit	8 bits	2 bits	None																																																														
DM 6647	00 to 15	Transmission delay (0000 to 9999 BCD sets a delay of 0 to 99,990 ms.) (Any other setting specifies a delay of 0 ms, causes a non-fatal error, and turns ON AR 1302.)																																																																
DM 6648	00 to 07	Node number (Host Link) 00 to 31 (BCD) (Any other setting specifies a node number of 00, causes a non-fatal error, and turns ON AR 1302.)																																																																
	08 to 11	Start code selection for no-protocol communications 0: Disables start code; 1: Enables start code in DM 6649 (Any other setting disables the start code, causes a non-fatal error, and turns ON AR 1302.)																																																																

	12 to 15	End code selection for no-protocol communications 0: Disables end code; 1: Enables end code in DM 6649; 2: Sets end code of CR, LF. (Any other setting disables the end code, causes a non-fatal error, and turns ON AR 1302.)
--	----------	--

Word(s)	Bit(s)	Function
DM 6649	00 to 07	Start code (00 to FF) (This setting is valid only when bits 8 to 11 of DM 6648 are set to 1.)
	08 to 15	When bits 12 to 15 of DM 6648 set to 0: Sets the number of bytes to receive. (00: 256 bytes; 01 to FF: 1 to 255 bytes) When bits 12 to 15 of DM 6648 set to 1: Sets the end code. (00 to FF)

### 4-1-2 Peripheral RS-422/485 Port Communications Settings

The following settings are effective after transfer to the PLC.  
If the 3G3MV-P10CDT Unit's Communications Switch is ON, communications through the peripheral port are governed by the default settings (all 0) regardless of the settings in DM 6650 through DM 6654.  
The 3G3MV-P10CDT's Communications Switch setting has no effect on communications with a Programming Console connected to the peripheral port or Support Software set for peripheral bus communications. The 3G3MV-P10CDT Unit will auto-detect either Programming Device and automatically establish communications.

Word(s)	Bit(s)	Function	
DM 6650	00 to 03	Port settings 0: Standard (1 start bit, 7 data bits, even parity, 2 stop bits, 9,600 bps), Host Link unit number: 0 1: Settings in DM 6651 (Any other setting will cause a non-fatal error and AR 1302 will turn ON.)	
	04 to 11	Not used.	
	12 to 15	Communications mode 0: Host Link or peripheral bus; 1: No-protocol (Any other setting causes a non-fatal error and turns ON AR 1302.)	
DM 6651	00 to 07	Baud rate 00: 1,200 bps; 01: 2,400 bps; 02: 4,800 bps; 03: 9,600 bps; 04: 19,200 bps	
	08 to 15	Frame format	
			Start bits      Data bits      Stop bits      Parity
		00:	1 bit      7 bits      1 bit      Even
		01:	1 bit      7 bits      1 bit      Odd
		02:	1 bit      7 bits      1 bit      None
		03:	1 bit      7 bits      2 bits      Even
		04:	1 bit      7 bits      2 bits      Odd
		05:	1 bit      7 bits      2 bits      None
		06:	1 bit      8 bits      1 bit      Even
		07:	1 bit      8 bits      1 bit      Odd
		08:	1 bit      8 bits      1 bit      None
09:	1 bit      8 bits      2 bits      Even		
10:	1 bit      8 bits      2 bits      Odd		
11:	1 bit      8 bits      2 bits      None		
		(Any other setting specifies standard settings (1 start bit, 7 data bits; even parity, 2 stop bits, 9,600 bps), causes a non-fatal error, and turns ON AR 1302.)	

DM 6652	00 to 15	Transmission delay (0000 to 9999 BCD sets a delay of 0 to 99,990 ms.) (Any other setting specifies a delay of 0 ms, causes a non-fatal error, and turns ON AR 1302.)
---------	----------	---

Word(s)	Bit(s)	Function
DM 6653	00 to 07	Node number (Host Link) 00 to 31 (BCD) (Any other setting specifies a node number of 00, causes a non-fatal error, and turns ON AR 1302.)
	08 to 11	Start code selection for no-protocol communications 0: Disables start code; 1: Enables start code in DM 6654 (Any other setting disables the start code, causes a non-fatal error, and turns ON AR 1302.)
	12 to 15	End code selection for no-protocol communications 0: Disables end code; 1: Enables end code in DM 6649; 2: Sets end code of CR, LF. (Any other setting disables the end code, causes a non-fatal error, and turns ON AR 1302.)
DM 6654	00 to 07	Start code (00 to FF) (This setting is valid only when bits 8 to 11 of DM 6653 are set to 1.)
	08 to 15	When bits 12 to 15 of DM 6653 set to 0: Sets the number of bytes to receive. (00: 256 bytes; 01 to FF: 1 to 255 bytes) When bits 12 to 15 of DM 6653 set to 1: Sets the end code. (00 to FF)

## 4-2 High-speed Counters

3G3MV-P10CDT Units have four points for high-speed counters: One point for a high-speed counter with a maximum response frequency of 20 kHz, and three points for interrupt inputs (counter mode).

For more details please refer to Programming Manual W353

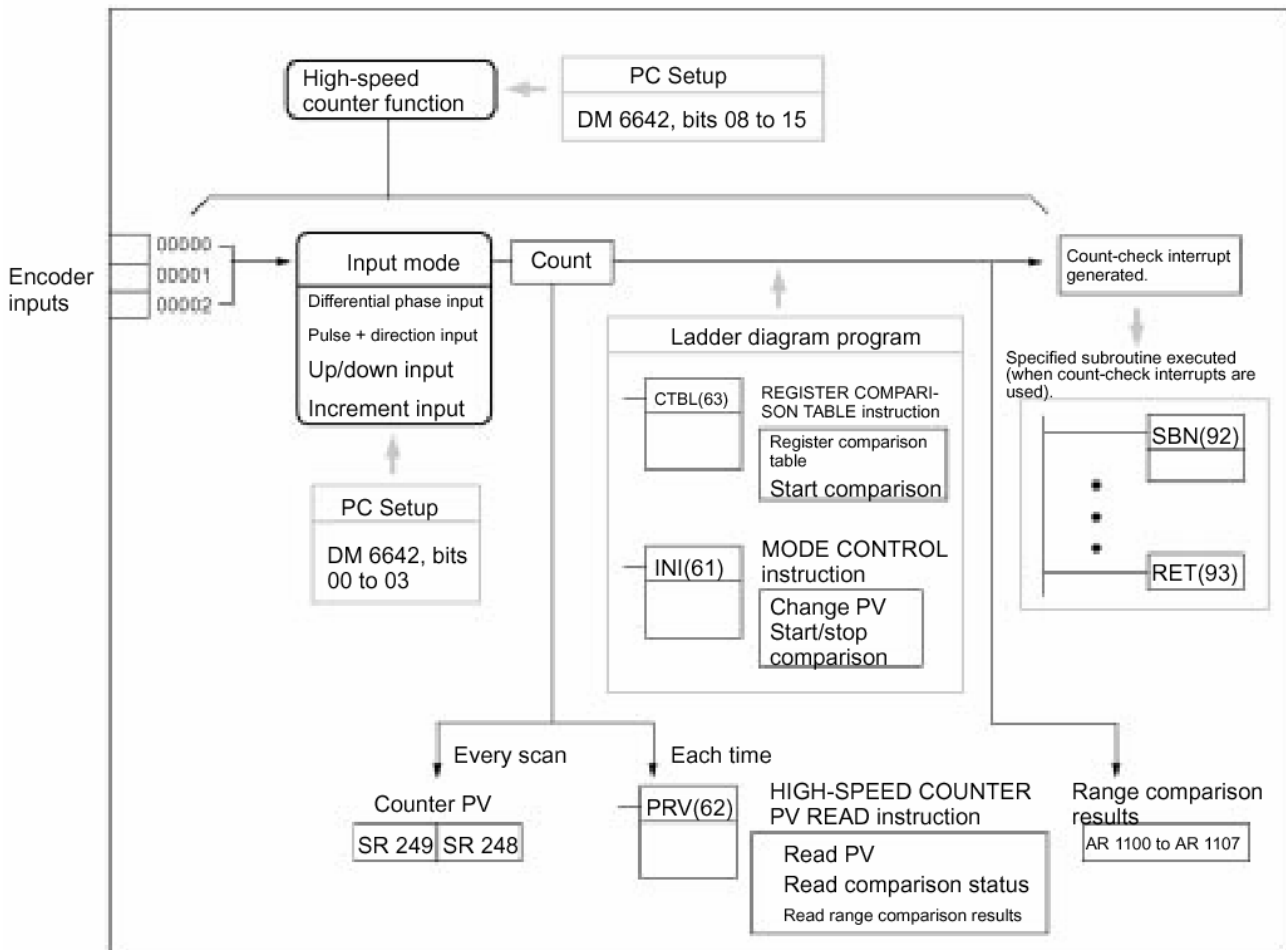
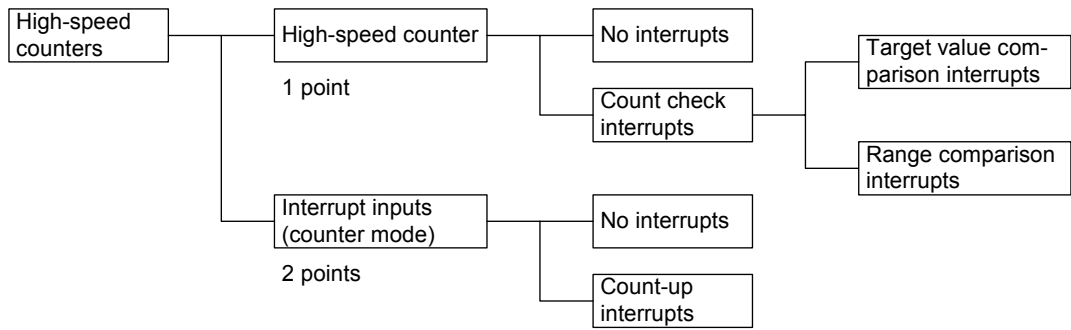

PLC Setup

Set the PLC Setup areas related to the high-speed counter as follows:

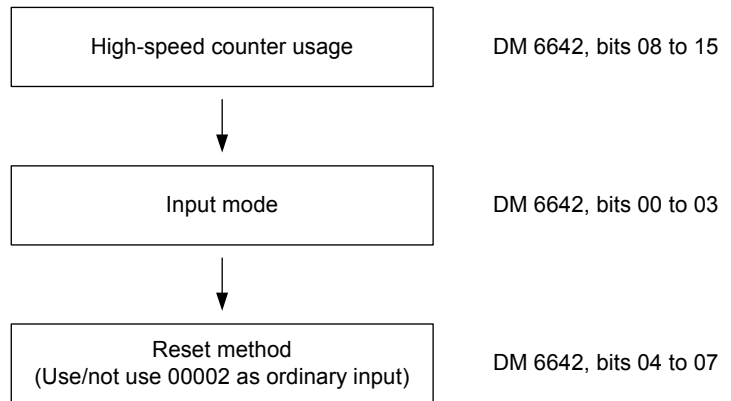

Word	Bits	Function	Setting
DM 6642	00 to 03	High-speed counter input mode setting 0: Differential phase input 5 kHz 1: Pulse + direction input 20 kHz 2: Up/down input 20 kHz 4: Increment 20 kHz	0, 1, 2, or 4
	04 to 07	High-speed counter reset method setting 0: Phase-Z signal + software reset 1: Software reset	0 or 1
	08 to 15	High-speed counter usage setting 00: Do not use. 01: Use as high-speed counter 02: Use as pulse synchronization control (10 Hz to 500 Hz) 03: Use as pulse synchronization control (20 Hz to 1 kHz) 04: Use as pulse synchronization control (300 Hz to 20 kHz)	01

The new settings for the System Setup go into effect when operation begins (when PROGRAM mode is changed to MONITOR or RUN mode), or when the 3G3MV-P10CDT's power is turned ON.

**Ladder Diagram Programming**

The following table shows the instructions related to high-speed counter control.

Instruction	Control	Operation
(@)CTBL(63)	Register target value comparison table	Registers target value comparison table.
	Register range comparison table	Registers range comparison table.
	Register target value comparison table and start comparison	Registers target value comparison table and starts comparison.
	Register range comparison table and start comparison	Registers range comparison table and starts comparison.
(@)INI(61)	Start comparison	Starts comparison with registered comparison table.
	Stop comparison	Stops comparison.
	Change PV	Changes the high-speed counter PV.
(@)PRV(62)	Read PV	Reads the high-speed counter PV.
	Read status	Reads the high-speed counter status.
	Read range comparison result	Reads range comparison result.
(@)INT(89)	Mask all interrupts	Prohibits all interrupts, including interrupt inputs, interval timer interrupts, high-speed counters, etc.
	Unmask all interrupts	Permits all interrupts, including interrupt inputs, interval timer interrupts, high-speed counters, etc.

The following table shows the data areas related to high-speed counter control.

Word	Bits	Name	Contents
248	00 to 15	High-speed counter PV	Reads high-speed counter PV.
249	00 to 15		
252	00	High-speed counter reset	When this bit turns ON, a software reset is triggered for the high-speed counter.
AR11	00 to 07	High-speed counter range comparison results	ON: Condition satisfied OFF: Condition not satisfied
	08	High-speed counter comparison	ON: Comparison in progress OFF: Comparison stopped
	09	High-speed counter PV overflow/underflow	ON: Overflow/underflow OFF: Normal

### 4-3 Input Interrupts In Counter Mode

The four built-in interrupt inputs in the 3G3MV-P10CDT Unit can be used in counter mode as inputs of up to 2 kHz. These inputs can be used as either incrementing counters or decrementing counters, triggering an interrupt (i.e., executing an interrupt subroutine) when the count matches the set value. For more details please refer to Programming Manual W353

#### Procedure for Using Interrupt Inputs in Counter Mode

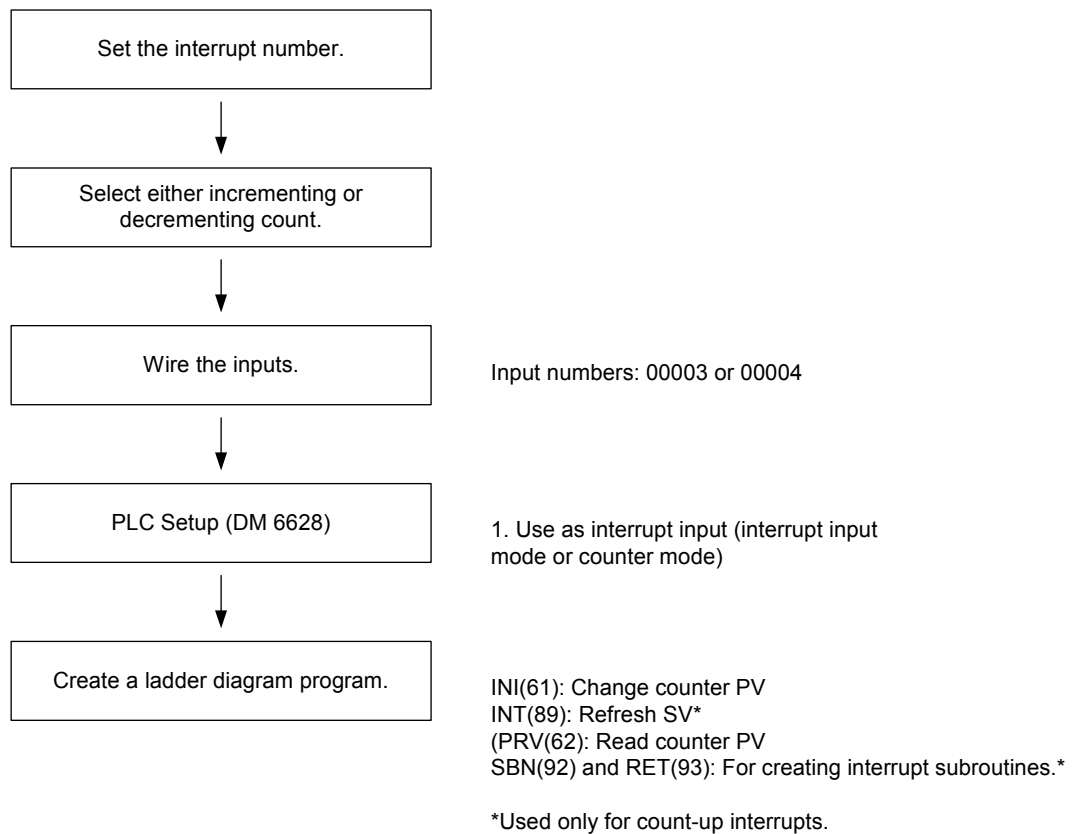

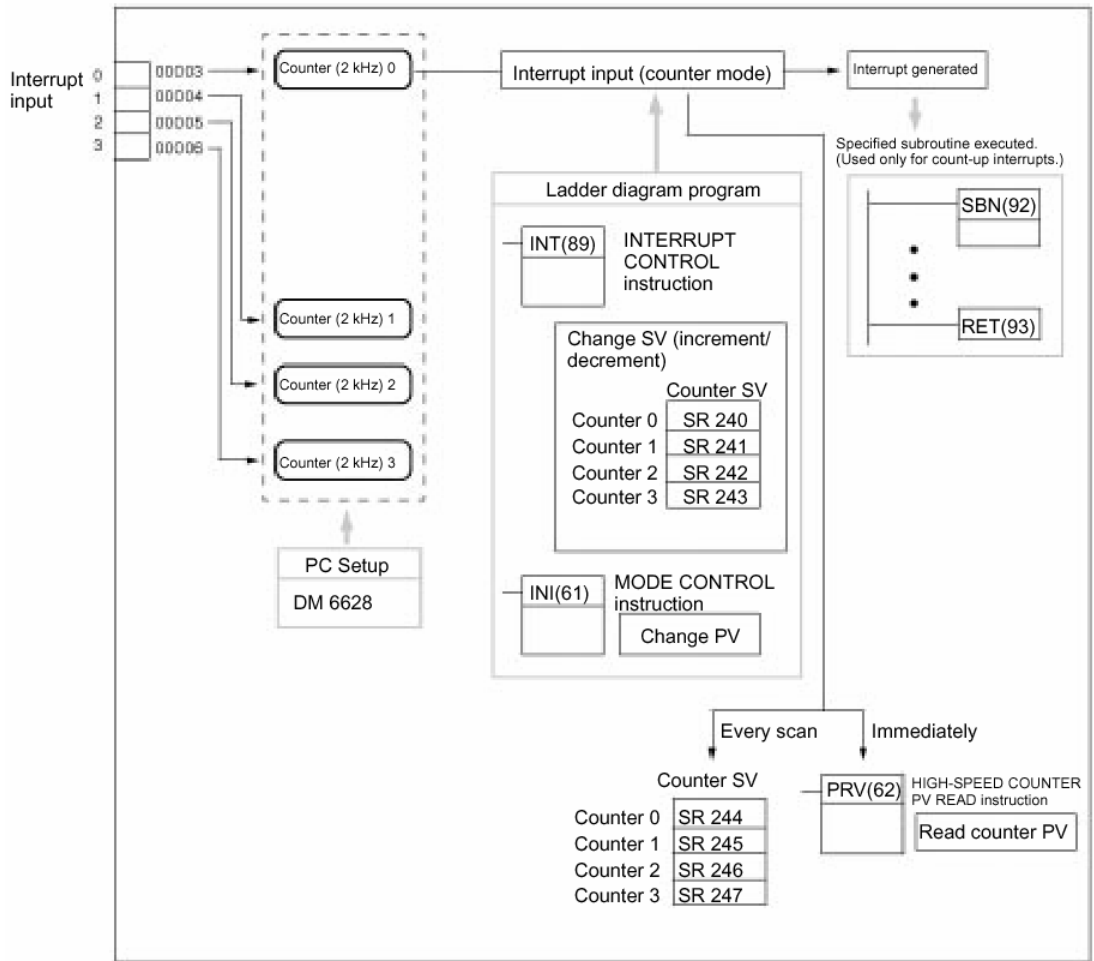

**PLC Setup**

The following table shows the settings in the PLC Setup area related to interrupt input usage.

Word	Bits	Function		Setting
DM 6628	00 to 03	Interrupt setting for input 00003	0: Normal input	1
	04 to 07	Interrupt setting for input 00004	1: Interrupt input (interrupt input mode or counter mode) 2: Quick-response input	
	08 to 15	Not used.		0

The setting will go into effect when the mode is changed (from PROGRAM to MONITOR/RUN) or when the power supply is turned ON to the 3G3MV-P10CDT.

**Ladder Diagram Programming**

The following table shows the instruction operations related to interrupt input (counter mode) control.

Instruction	Control	Operation
(@)INT(89)	Refresh incrementing counter SV	Refreshes the counter's SV and starts the incrementing count.
	Refresh decrementing counter SV	Refreshes the counter's SV and starts the decrementing count.
	Mask all interrupts	Prohibits all interrupts, including interrupt inputs, interval timer interrupts, high-speed counters, etc.
	Unmask all interrupts	Permits all interrupts, including interrupt inputs, interval timer interrupts, high-speed counters, etc.
(@)INI(61)	Change PV	Changes the counter's PV.
(@)PRV(62)	Read PV	Reads the counter's PV.

The functions related to input interrupts (counter mode) are executed according to the data areas shown in the following table.

Word	Bits	Name	Contents
240	00 to 15	SV area for input interrupt (counter mode) 0	Stores the counter's set value(SV) .
241	00 to 15	SV area for input interrupt (counter mode) 1	
242	00 to 15	SV area for input interrupt (counter mode) 2	
243	00 to 15	SV area for input interrupt (counter mode) 3	
244	00 to 15	PV area for input interrupt (counter mode) 0	Stores the counter's present value (PV).
245	00 to 15	PV area for input interrupt (counter mode) 1	
246	00 to 15	PV area for input interrupt (counter mode) 2	
247	00 to 15	PV area for input interrupt (counter mode) 3	

**Refresh Incrementing Counter SV / Refresh Decrementing Counter SV**

These functions store the counter's set values in data areas and refresh them by means of INT(89). In this way, they start the count operation for interrupt inputs (counter mode) and they permit interrupts.

**Storing Set Values in Data Areas**

The counter's set values are stored in words 240, 241, 242, and 243.

SR 240	SV for interrupt input (count mode) 0: 0000 to FFFF
SR 241	SV for interrupt input (count mode) 1: 0000 to FFFF
SR 242	SV for interrupt input (count mode) 2: 0000 to FFFF
SR 243	SV for interrupt input (count mode) 3: 0000 to FFFF

### 4-4 Pulse Output Functions

The 3G3MV-P10CDT has two pulse outputs. By means of a selection in the PLC Setup, these outputs can be used as two single-phase outputs without acceleration and deceleration, two variable duty ratio pulse outputs, or pulse outputs with trapezoidal acceleration/deceleration (one pulse + direction output and one up/ down pulse output). The pulse output PV coordinate system can also be specified in the PLC Setup as either relative or absolute.

There are two pulse output modes: Independent mode, in which outputs are stopped at a preset amount of pulses, and continuous mode, in which outputs are stopped by an instruction.

For more details please refer to Programming Manual W353

Item		Single-phase pulse outputs without accel/decel	Variable duty ratio pulse outputs	Single-phase pulse outputs with trapezoidal acceleration/deceleration			
				Pulse + direction outputs		Up/down pulse outputs	
Execution instructions		PULS(65) and SPED(64)	PWM(—)	PULS(65) and ACC(—)			
Output number	01000	Pulse output 0 (See note 1.)	Pulse output 0 (See note 1.)	Pulse output 0	Pulse output	Pulse output 0	CW pulse output
	01001	Pulse output 1 (See note 1.)	Pulse output 1 (See note 1.)		Direction output		CCW pulse output
Output frequency range		10 Hz to 10 kHz	0.1 to 999.9 Hz	10 Hz to 10 kHz		10 Hz to 10 kHz	
	Pitch	10 Hz	0.1 Hz	10 Hz		10 Hz	
Up/down frequency pitch		---	---	10 Hz (See note 2.)		10 Hz (See note 2.)	
Start speed pitch		---	---	10 Hz		10 Hz	
Output mode		Continuous, Independent	Continuous	Continuous, Independent		Continuous, Independent	
	Number of pulses	1 to 16777215	---	±1 to 16777215		±1 to 16777215	
Duty ratio (See note 3.)		50%	0 to 100%	50%		50%	
Control method	Movement specification	Yes	No	Yes		Yes	
	Accel/decel specification	No	No	Yes		Yes	
	Start speed specification	No	No	Yes		Yes	
	Duty specification	No	Yes	No		No	

- Note**
1. With single-phase pulse outputs, pulse outputs 0 and 1 can each be output independently.
  2. Pulse outputs can be accelerated or decelerated in units of 10 Hz every 10 ms.
  3. Actual pulses are affected by the transistor output's ON response time (20 μs max.) and OFF response time (40 μs max.).

### 4-4-1 Using Single-phase Pulse Fixed Duty Ratio

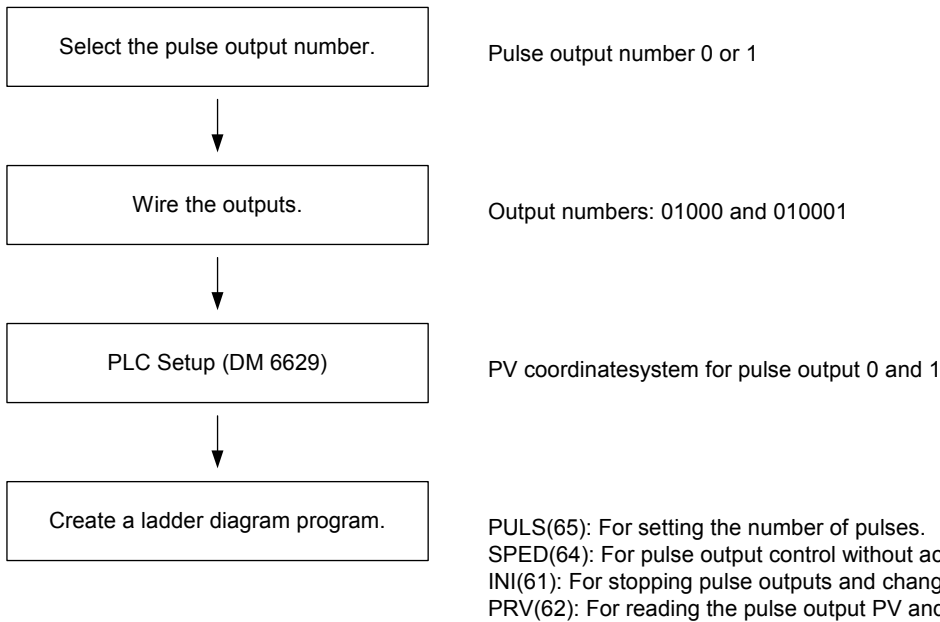

#### Single-phase Pulse Outputs

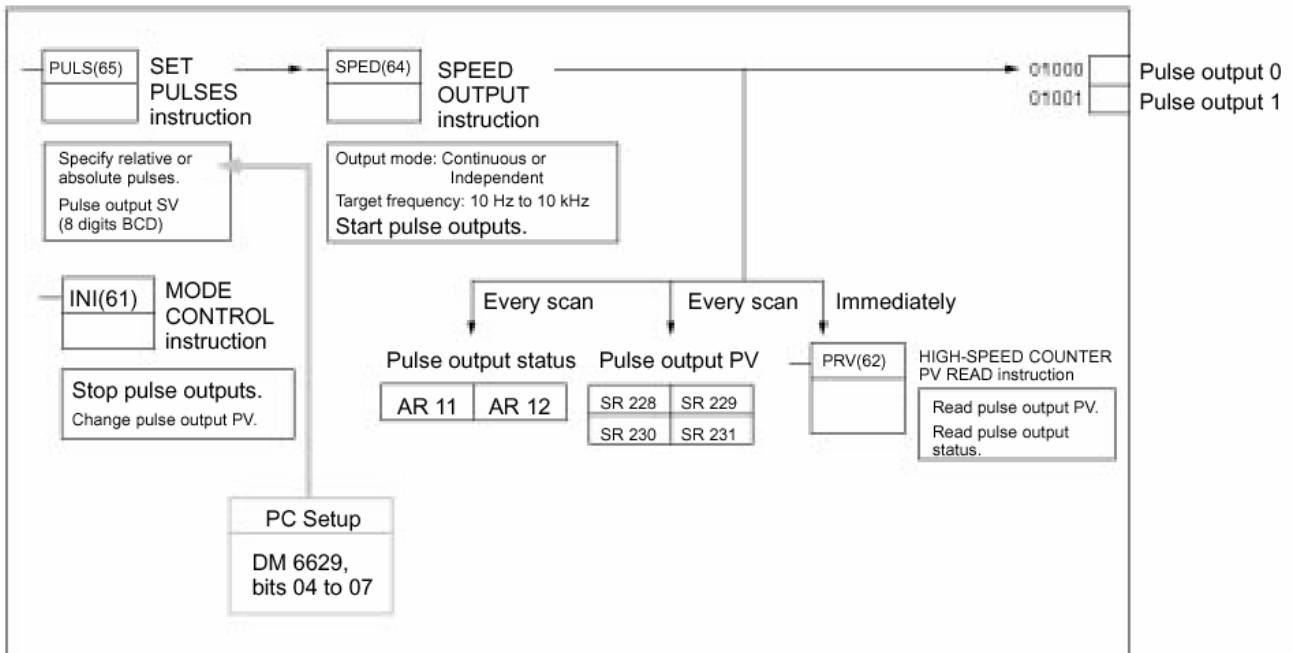

#### PLC Setup

Make the following settings in the PLC Setup.

Word	Bits	Function	Setting
DM 6629	00 to 03	Pulse 0 PV coordinate system	0: Relative coordinate system 1: Absolute coordinate system
	04 to 07	Pulse 1 PV coordinate system	

DM 6642	08 to 15	High-speed counter setting	00: Do not use. 01: Use as high-speed counter 02: Use as synchronized pulse control (10 to 500 Hz). 03: Use as synchronized pulse control (20 Hz to 1 kHz). 04: Use as synchronized pulse control (300 Hz to 20 kHz).	Either 00 or 01
---------	----------	----------------------------	---	-----------------

If absolute pulses are specified with PULS(65), be sure to set the absolute coordinate system (1).

Synchronized pulse control cannot be used simultaneously.

The settings will go into effect when the mode is changed (from PROGRAM to MONITOR/RUN) or when the power supply is turned ON to the PLC.

The following table shows the instruction operations related to pulse outputs without acceleration and deceleration (fixed duty ratio).

**Ladder Diagram Programming**

Instruction	Control	Operation
(@)PULS(65)	Set number of pulses	Sets the number of pulses to be output in independent mode.
(@)SPED(64)	Set frequency and start pulse outputs	Sets the frequency for outputs in the independent mode or continuous mode, and starts the pulse outputs.
	Change frequency	Changes the frequency for outputs in the independent mode or continuous mode.
	Stop pulse outputs	Stops the pulse outputs (by changing the speed to a frequency of 0 Hz).
(@)INI(61)	Stop pulse outputs	Stops the pulse outputs.
	Change pulse output PV	Changes the pulse output PV.
(@)PRV(62)	Read pulse output PV	Reads the pulse output PV.
	Read pulse output status	Reads the pulse output status.

The following table shows the words and bits related to pulse outputs without acceleration and deceleration (fixed duty ratio).

Word	Bits	Name	Contents
228	00 to 15	Pulse output PV 0, rightmost 4 digits	Cannot be used as work bits even when not used as pulse outputs.
229	00 to 15	Pulse output PV 0, leftmost 4 digits	
230	00 to 15	Pulse output PV 1, rightmost 4 digits	
231	00 to 15	Pulse output PV 1, leftmost 4 digits	
252	04	Pulse output 0 PV reset	Clears PV 0 when ON.
	05	Pulse output 1 PV reset	Clears PV 1 when ON.
AR 11	12	Pulse output 0 PV overflow/underflow	ON: Occurred OFF: Normal
	13	Number of pulses set for pulse output 0	ON: Set (by PULS(65)) OFF: Not set
	14	Pulse output completed for pulse output 0	ON: Completed (by SPED(64)) OFF: Not completed
	15	Pulse output in progress for pulse output 0	ON: In progress (by SPED(64)) OFF: Stopped
AR 12	12	Pulse output 1 PV overflow/underflow	ON: Occurred OFF: Normal
	13	Number of pulses set for pulse output 1	ON: Set (by PULS(65)) OFF: Not set
	14	Pulse output completed for pulse output 1	ON: Completed (by SPED(64)) OFF: Not completed
	15	Pulse output in progress for pulse output 0	ON: In progress (by SPED(64)) OFF: Stopped

### 4-4-2 Using Pulse Outputs With Variable Duty Ratio

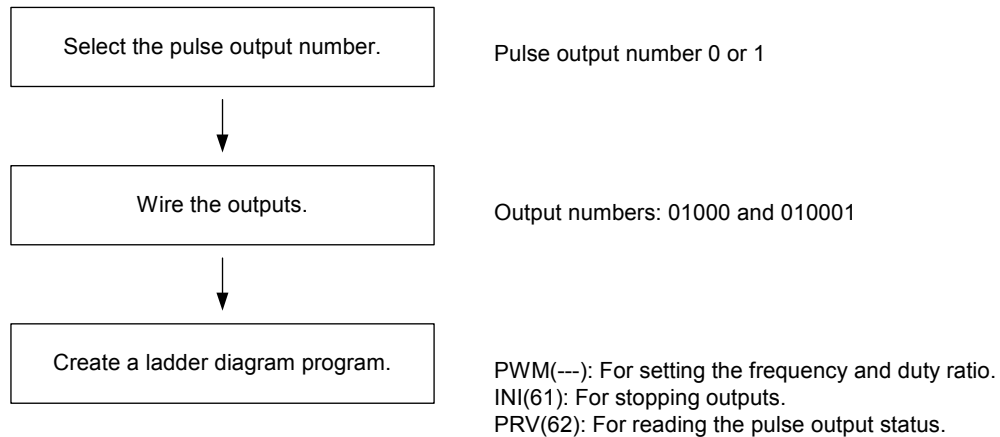

#### Pulse Outputs With Variable Duty Ratio

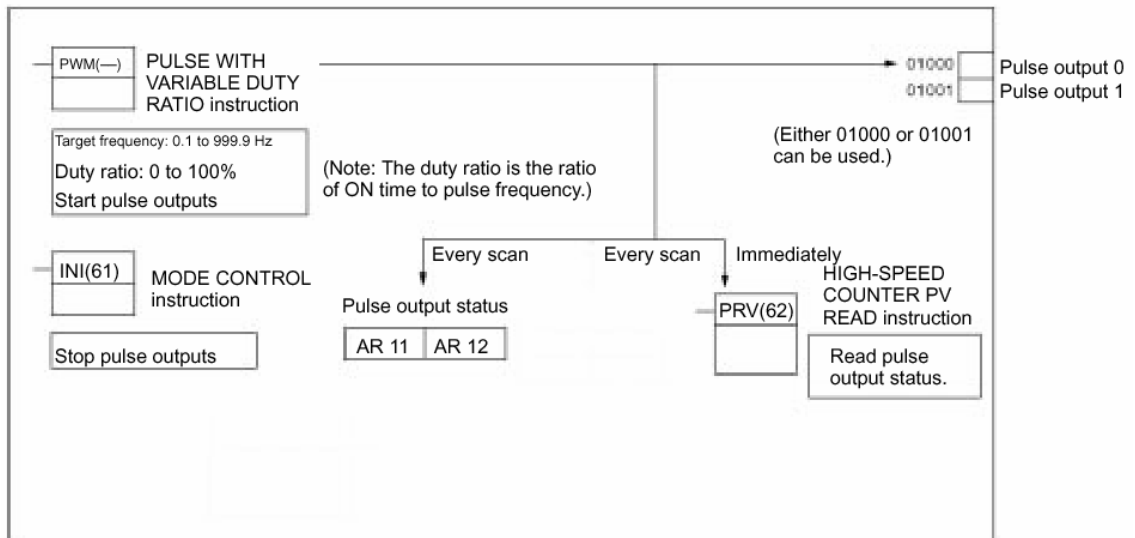

#### PLC Setup

Make the following settings in the PLC Setup.

Word	Bits	Function		Setting
DM 6642	08 to 15	High-speed counter setting	00: Do not use. 01: Use as high-speed counter 02: Use as synchronized pulse control (10 to 500 Hz). 03: Use as synchronized pulse control (20 Hz to 1 kHz). 04: Use as synchronized pulse control (300 Hz to 20 kHz).	Either 00 or 01

Synchronized pulse control cannot be used simultaneously. The settings will go into effect when the mode is changed (from PROGRAM to MONITOR/RUN) or when the power supply is turned ON to the PLC.

**Ladder Diagram Programming**

The following table shows the instruction operations related to pulse outputs with variable duty ratio.

Instruction	Control	Operation
(@)PWM(—)	Pulse output with variable duty ratio	Sets the frequency and duty ratio and starts the pulse outputs.
	Change duty ratio	Changes the duty ratio during pulse while pulse outputs with variable duty ratio are already in progress.
(@)INI(61)	Stop pulse outputs	Stops the pulse outputs.
(@)PRV(62)	Read pulse output status	Reads the pulse output status (during pulse outputs).

The following table shows the words and bits related to pulse outputs with variable duty ratio.

Word	Bit	Name	Contents
AR 11	15	Pulse output in progress for pulse output 0	ON: In progress (by SPED(64), ACC(—), or PWM(—)) OFF: Stopped
AR 12	15	Pulse output in progress for pulse output 1	ON: In progress (by SPED(64), ACC(—), or PWM(—)) OFF: Stopped

**4-4-3 Using Pulse Outputs With Trapezoidal Acceleration/Deceleration**

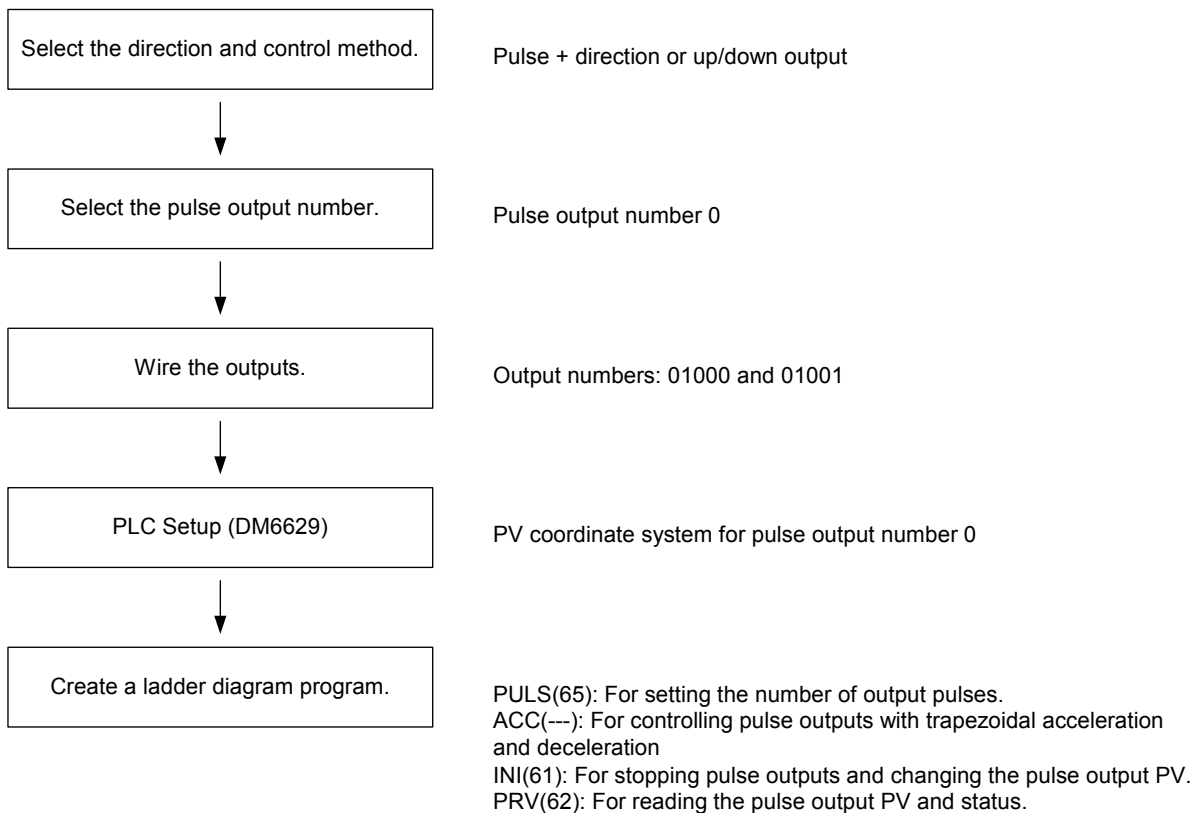

Pulse Outputs With Trapezoidal Acceleration and Deceleration

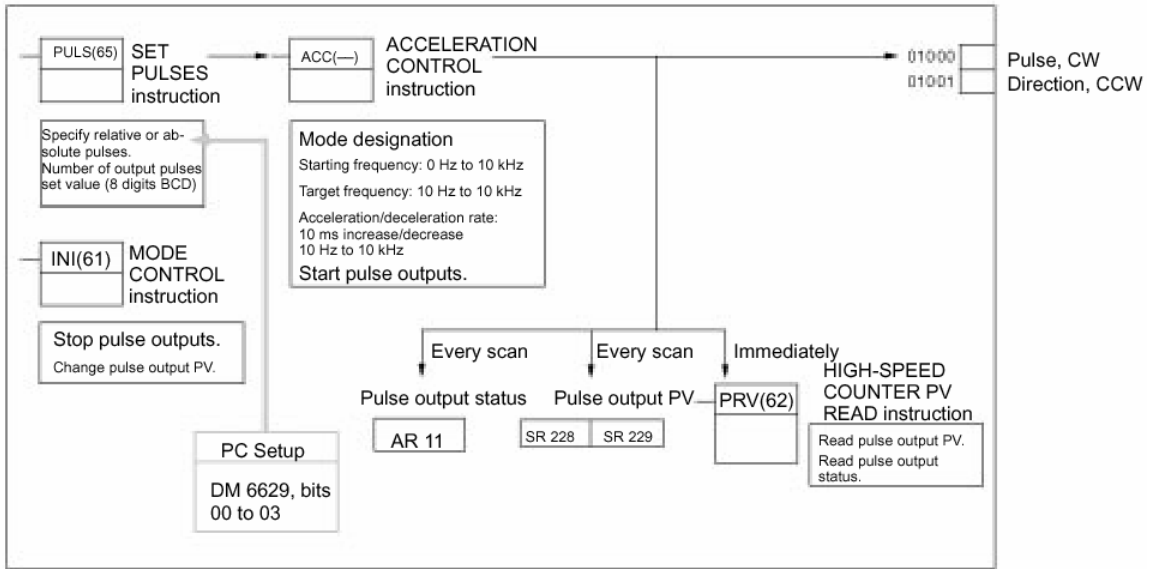

PLC Setup

Make the following settings in the PLC Setup.

Word	Bits	Function	Setting
DM 6629	00 to 03	Pulse 0 PV coordinate system	0: Relative coordinate system 1: Absolute coordinate system
DM 6642	08 to 15	High-speed counter setting	00: Do not use. 01: Use as high-speed counter 02: Use as synchronized pulse control (10 to 500 Hz). 03: Use as synchronized pulse control (20 Hz to 1 kHz). 04: Use as synchronized pulse control (300 Hz to 20 kHz).

If absolute pulses are specified with PULS(65), be sure to set the absolute coordinate system (1).

Synchronized pulse control cannot be used simultaneously.

The settings will go into effect when the mode is changed (from PROGRAM to MONITOR/RUN) or when the power supply is turned ON to the PLC.

**Ladder Diagram Programming**

The following table shows the instruction operations related to pulse outputs with trapezoidal acceleration and deceleration (fixed duty ratio).

Instruction	Control	Operation
(@)PULS(65)	Set number of pulses	Sets the number of pulses to be output in independent mode.
(@)ACC(—)	Set frequency and start pulse outputs	Sets the target frequency, starting frequency, and acceleration/deceleration rate for outputs in independent mode or continuous mode, and starts the pulse outputs.
	Change frequency	Changes the frequency during pulse output in continuous mode by accelerating or decelerating according to the specified acceleration/deceleration rate.
	Stop pulse outputs	Decelerates pulse outputs to a stop according to the specified acceleration/deceleration rate.
(@)INI(61)	Stop (decelerate stop) pulse outputs	Stops the pulse outputs.
	Change pulse output PV	Changes the pulse output PV.
(@)PRV(62)	Read pulse output PV	Reads the pulse output PV.
	Read pulse output status	Reads the pulse output status.

The following table shows the words and bits related to pulse outputs with trapezoidal acceleration and deceleration (fixed duty ratio).

Word	Bits	Name	Contents
228	00 to 15	Pulse output PV 0, rightmost 4 digits	Cannot be used as work bits even when not used as pulse outputs.
229	00 to 15	Pulse output PV 0, leftmost 4 digits	
230	00 to 15	Pulse output PV 1, rightmost 4 digits	
231	00 to 15	Pulse output PV 1, leftmost 4 digits	
252	04	Pulse output 0 PV reset	Clears PV 0 when ON.
	05	Pulse output 1 PV reset	Clears PV 1 when ON.
AR 11	11	Pulse output status for pulse output 0	ON: Accelerating or decelerating OFF: Constant speed
	12	Pulse output 0 PV overflow/underflow	ON: Occurred OFF: Normal
	13	Number of pulses set for pulse output 0	ON: Set OFF: Not set
	14	Pulse output completed for pulse output 0	ON: Completed OFF: Not completed
	15	Pulse output in progress for pulse output 0	ON: In progress (by SPED(64), ACC(—), or PWM(—)) OFF: Stopped

## SECTION 5 Inverter Interface

This section describes the interface to the Inverter.

5-1	Inverter interface.....	57
5-2	I/O Allocation IR.....	57
5-3	I/O Allocation DM.....	60
	5-3-1 <i>Controlling Inverter I/O</i> .....	61
5-4	Transfer command.....	61
	5-4-1 <i>Parameter Reading</i> .....	62
	5-4-2 <i>Parameter Writing</i> .....	63
	5-4-3 <i>Transfer Timing Chart</i> .....	64
	5-4-4 <i>Transfer Timing Chart in case of Errors</i> .....	65
	5-4-5 <i>Transfer Timing Chart for Cancelling Processing</i> .....	66
	5-4-6 <i>Transfer Ladder Program</i> .....	66

## 5-1 Inverter interface

The communication between the PLC and the Inverter is performed by:

- Inverter functionality mapped in IR (section 5-2)
- Inverter functionality mapped in DM (section 5-3)
- Through the Transfer command (section 5-4)

## 5-2 I/O Allocation IR

The contents of the IR area is refreshed and updated with each scan.

Word(s)	Bit(s)	Function	Inverter Register	Read/write
200	00	RUN (ON: During RUN)	002C.0	Read-only
	01	Zero speed (ON: Zero speed)	002C.1	
	02	Reverse operation (ON: Reverse operation)	0001.1	
	03	Error-reset signal (IR 20709) (ON: Error-reset signal active)	---	
	04	Frequency agree (ON: Frequency agree)	002C.2	
	05	Inverter ready (ON: Inverter ready)	002C.6	
	06	Warning (nonfatal error) (ON: Warning occurring)	002C.3	
	07	Fault (ON: Fault occurring)	002C.14	
	08	OPE error (ON: OPE error occurring)	---	
	09	Momentary power interruption recovery (ON: Power restored)	---	
	10	RUN command mode (ON: Controlled by Inverter interface; OFF: Other)	002C.10	
	11	Terminal MA output status (ON: Closed)	002D.0	
	12	Terminal P1 output status (ON: Closed)	002D.1	
	13	Terminal P2 output status (ON: Closed)	002D.2	
14 to 15	<i>Reserved</i>	---		
201	00	<i>Reserved</i>	---	Read-only
	01	Main circuit voltage low (UV1)	0021.12	
	02	Control power supply error (UV2)	0021.13	
	03	<i>Reserved</i>	---	
	04	Load short-circuit (SC) (Note 1.)	0029.0	
	05	Ground fault (GF) (Note 1.)	0029.1	
	06	Overcurrent (OC)	0021.0	
	07	Overvoltage (OV)	0021.1	
	08	Inverter overheat (OH)	0021.3	
	09	<i>Reserved</i>	---	
	10	Motor overload (OL1)	0021.9	
	11	Inverter overload (OL2)	0021.2	
	12	Overtorque detection (OL3)	0021.10	
13 to 15	<i>Reserved</i>	---		
202	00	External fault 3 (EF3)	---	Read-only
	01	External fault 4 (EF4)	---	
	02	External fault 5 (EF5)	---	
	03	External fault 6 (EF6)	---	
	04	External fault 7 (EF7)	---	
	05 to 09	<i>Reserved</i>	---	
	10	Input phase-failure (PF) (Note 1.)	0029.2	
11	Output phase-failure (LF) (Note 1.)	0029.3		

	12	<i>Reserved</i>	---	
	13	Operator connection error (OPR)	0021.15	
	14 to 15	<i>Reserved</i>	---	
<b>Word(s)</b>	<b>Bit(s)</b>	<b>Function</b>	<b>Inverter Register</b>	<b>Read/write</b>
203	00 to 05	<i>Reserved</i>	---	Read-only
	06	External fault (EF0)	0021.7	
	07	Loss of PID feedback (FBL)	0021.6	
	08	Low torque detection (UL3)	---	
	09 to 14	<i>Reserved</i>	---	
	15	Hardware error (Fxx)	0021.8	
204	00	Terminal S1 (ON: Closed)	002B.0	Read-only
	01	Terminal S2 (ON: Closed)	002B.1	
	02	Terminal S3 (ON: Closed)	002B.2	
	03	Terminal S4 (ON: Closed)	002B.3	
	04	Terminal S5 (ON: Closed)	002B.4	
	05	Terminal S6 (ON: Closed)	002B.5	
	06	Terminal S7 (ON: Closed)	002B.6	
	07 to 15	<i>Reserved</i>	---	
205	00	NetRef status (OFF: Inverter reference enabled; ON: PLC enabled) (Note 2.)	---	Read-only
	01	NetCtrl status(OFF: Inverter control enabled; ON: PLC enabled) (Note 3.)	---	
	02 to 07	<i>Reserved</i>	---	
	08	Stall prevention operating flag	---	
	09 to 15	<i>Reserved</i>	---	
206	00	Inverter Ready (error detected by mutual diagnosis) (ON: Normal; OFF: Error)	---	Read-only
	01	Transfer Completion (ON: Transfer completed)	---	
	02	Transfer Error (ON: Error; OFF: Normal)	---	
	03	Transfer Busy (ON: Busy; OFF: Ready for transfer)	---	
	04 to 15	<i>Reserved</i>	---	
207	00	Forward/Stop (ON: Forward operation)	---	Read/write
	01	Reverse/Stop (ON: Reverse operation)	---	
	02	Multi-function input 3 (Set by n052.)	0001.6	
	03	Multi-function input 4 (Set by n053.)	0001.7	
	04	Multi-function input 5 (Set by n054.)	0001.8	
	05	Multi-function input 6 (Set by n055.)	0001.9	
	06	Multi-function input 7 (Set by n056.)	001.10	
	07	<i>Reserved</i>	---	
	08	External fault (ON: Fault EFO)	0001.2	
	09	Fault reset (ON: Reset command)	0001.3	
	10 to 13	<i>Reserved</i>	---	
	14	Error log clear	---	
	15	External Baseblock command (BB) (Note 1.)	002A.3	
208	00	Multi-function contact output (ON: Output ON)	0009.0	Read/write
	01	Multi-function output 1 (ON: Output ON)	0009.1	
	02	Multi-function output 2 (ON: Output ON)	0009.2	
	03 to 15	<i>Reserved</i>	---	
209	00	/NetRef 1 (ON: Inverter reference enabled; OFF: PLC enabled) (Note 4.)	---	Read/write

	01	/NetCtrl 1 (ON: Inverter control enabled; OFF: PLC enabled) (Note 5.)	---	
	02 to 15	<i>Reserved</i>	---	

Word(s)	Bit(s)	Function	Inverter Register	Read/write
210	00	Transfer Command (Read) (ON: Start processing)	---	Read/write
	01	Transfer Command (Write) (ON: Start processing)	---	
	02 to 15	<i>Reserved</i>	---	
211 to 217	00 to 15	Reserved. Can be used as work bits.	---	Read/write

- Note 1.** These functions are provided for 5.5kW and 7.5kW Inverters only.
- Note 2.** NetRef is the inverse of /NetRef (209.00)
- Note 3.** NetCtrl is the inverse of /NetCtrl (209.01)
- Note 4.** When /NetRef is turned OFF, the PLC is defining the Frequency Reference  
When /NetRef is turned ON, the Inverter is defining the Frequency Reference  
After power on the this bit is turned OFF (PLC reference)
- Note 5.** When /NetCtrl is turned OFF, the PLC is controlling the Inverter  
When /NetCtrl is turned ON, other sources are controlling the Inverter  
After power on the this bit is turned OFF (PLC controlling)

 **Caution** At power up, the following Inverter status flags toggle before they reflect the actual status of the Inverter:

- IR 200.05 Inverter Ready
- IR 200.06 Inverter Warning

Wait at least 28 ms before using these flags.

 **Caution** This unit has no power-break process (automatic fail-safe operation after power has been removed to the Unit). After detecting UV1 in the Inverter (main circuit low, IR 201.01), there is a sufficient amount of time (depending on the load) until its voltage goes down. The ladder program should contain this mechanism to design necessary safety operations to deal with this power-down situation.

### 5-3 I/O Allocation DM

The contents of the DM area is refreshed and updated with each scan.

Word(s)	Function	Inverter Register	Read/write
2022	Specifies the Inverter operation in case a fatal error occurs in the program. (Leftmost 3 digits are invalid.) When last digit is other than 1: Data to Inverter is cleared continuously. When last digit is 1: Data to Inverter is frozen.	---	Read/write
2023	Destination address for storing transferred data (4 digits BCD): L (Note 1.)	---	Read/write
2024	Destination address for storing transfer response data (4 digits BCD): K (Note 1.)	---	Read/write
2025	Speed feedback	---	Read-only
2026	Torque reference (Unit: 0.1%)	0032	Read-only
2027	<i>Reserved</i>	---	Read-only
2028	Frequency reference monitor (Unit: According to n035)	0023	Read-only
2029	Output frequency monitor (Unit: According to n035)	0024	Read-only
2030	Output current monitor (Unit: 0.01 A)	0027	Read-only
2031	Pulse input (Unit: 0.1%)	---	Read-only
2032	Main circuit DC voltage monitor (Unit: 1 V)	0031	Read-only
2033	<i>Reserved</i>	---	Read-only
2034	Analog frequency reference terminal monitor (Unit: 0.1%)	---	Read-only
2035	<i>Reserved</i>	---	Read-only
2036	Frequency reference (Unit: According to n035)	0002	Read/write
2037 to 2040	<i>Reserved</i>	---	Read/write

**Note 1** The value (DM0000 to DM1985) is sampled when the Transfer Command Bit is turned ON.



**Caution**

At power up, the following words change before they reflect the actual status of the Inverter:

- DM2032 Main DC voltage monitor
- DM2034 Analog frequency reference terminal monitor

Wait at least 28 ms before using these words.

### 5-3-1 Controlling Inverter I/O

**Inputs**

By default, all inputs can be monitored in IR (Ch204). However, they may have functionality attached to it. The function can be changed using n50..n56.

**Note** Setting the corresponding bit in Ch207 an input can be turned on. The analog input can be monitored in DM2034.

**Outputs**

By default, outputs can not be controlled in IR. To control the outputs (Bits 0..2 in Ch208) the corresponding output setting (n57..59) must be set to "18". This means that 'communication' (in this case the 3G3MV-P10CDT) controls the corresponding output.

### 5-4 Transfer command

Parameters which are accessible through a corresponding Modbus register inside the 3G3MV Inverter, can be accessed by using the Transfer command.

The Transfer command is controlled by

- Two command bits: one for reading and one for writing
- Three status flags: busy-, completion- and error-flag
- Two DM area's: one for specifying the command, one for specifying the response location.

**Note** Changes to parameters may not take effect immediately. Refer to the 3G3MV Manual for details.

All parameters accessed with the Transfer command use the register numbers and formats of the Modbus-interface as defined by 3G3MV.

**Note** The following parameters have different register numbers when accessed through the Transfer functionality compared to accessing through Modbus:

Parameter	Transfer register number
n128	1D3H
n129	1D4H
U-03	3BH

**Note** The data-format of following parameters are different when accessed through the Transfer functionality compared to accessing through Modbus:

Parameter	Value	Function
n002	0	V/f mode
	2	Vector control mode

**5-4-1 Parameter Reading**

To read the contents of a 3G3MV parameter, the corresponding Inverter register must be specified in the DM area specified by L (DM2023). Refer to the 3G3MV manual for the Inverter register definitions.

A maximum number of 8 data items can be transferred in one operation.

<b>Words</b>	<b>Function</b>
L+0	Number of data words including L (binary)
L+1	Transfer destination Inverter register (4 digits binary)
L+2	Number of transferred data items (4 digits binary)

The response to the read command is stored in the DM area specified by K (DM2024).

In case of a normal completion:

<b>Words</b>	<b>Function</b>
K+0	Number of data words including K (binary)
K+1	Transfer destination Inverter address 1 (4 digits binary)
K+2	Number of transferred data items 1 (4 digits binary)
K+3	Read data 1-1 (4 digits binary)
K+4	Read data 1-2 (4 digits binary)
K+5	...
K+6	...
K+7	...
K+8	...
K+9	...
K+10	...

In case of a completion which resulted in an error:

<b>Words</b>	<b>Function</b>
K+0	Number of data words including K (0002)
K+1	Error code (Note 1)

**Note 1** For the error codes see section 5-4-7.

**5-4-2 Parameter Writing**

To write a 3G3MV parameter, the corresponding Inverter register must be specified in the DM area specified by L (DM2023). Refer to the 3G3MV manual for the Inverter register definitions.

A maximum number of 8 data items can be transferred in one operation.

<b>Words</b>	<b>Function</b>
L+0	Number of data words including L (binary)
L+1	Transfer destination Inverter address (4 digits binary)
L+2	Number of transferred data items (4 digits binary)
L+3	Write data 1-1 (4 digits binary)
L+4	Write data 1-2 (4 digits binary)
L+5	...
L+6	...
L+7	...
L+8	...
L+9	...
L+10	...

Response data is stored in the DM area specified by K (DM2024).

In case of a normal completion:

<b>Words</b>	<b>Function</b>
K+0	Number of data items (0002)
K+1	Normal response code (0000)

PLC Transfer Response Data Storage Destination; DM Area: K

<b>Words</b>	<b>Function</b>
K+0	Number of data items (0002)
K+1	Error code (Note 1.)

**Note 1** For the error codes see section 5-4-7.

**5-4-3 Transfer Timing Chart**

The diagram below shows the timing of the Transfer command with a normal completion. The timing is the same for reading and writing.

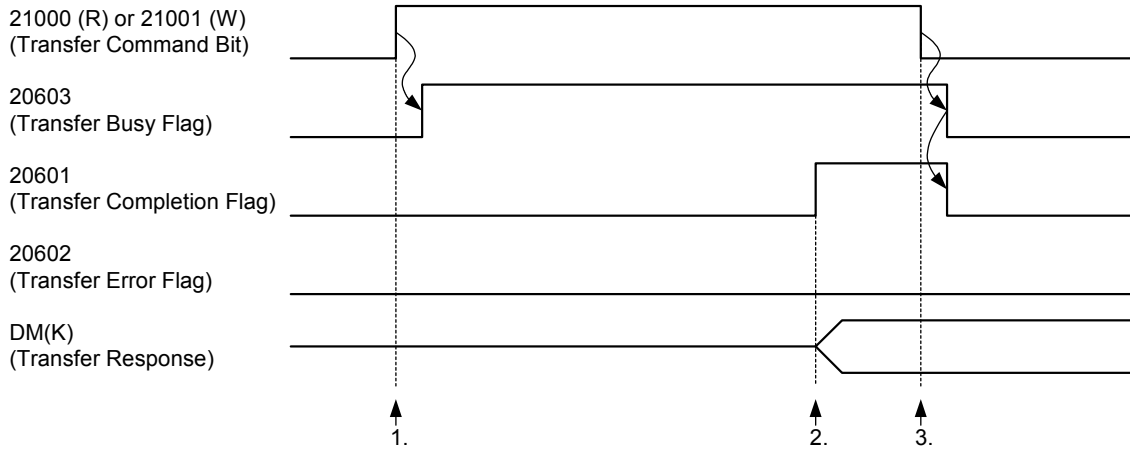

**Operation**

1. When the Transfer Command Bit is turned ON, the Transfer Busy Flag will turn ON one PLC cycle later, and the command specified in the DM Area (L) will be processed.
2. When the Transfer Completion Flag is turned ON, the response is present in the DM Area (K).
3. When the Transfer Command Bit is turned OFF, the Transfer Busy Flag and Transfer Completion Flag will turn OFF one PLC cycle later.

**Timing**

The time required for the Transfer command (between 1. and 2.) depends on the PLC cycle time and the presence of the Digital Operator according the table below:

Digital Operator	Minimum	Maximum
No	1 PLC cycle	6 ms
Yes	1 PLC cycle	24 ms

**5-4-4 Transfer Timing Chart in case of Errors**

The diagram below shows the timing of the Transfer command which resulted in an error. The timing is the same for reading and writing.

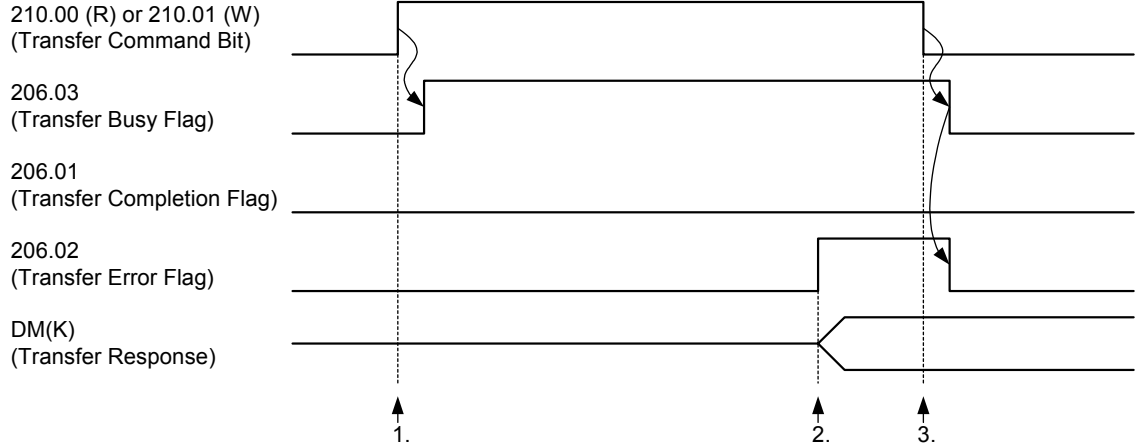

**Operation**

1. When the Transfer Command Bit is turned ON, the Transfer Busy Flag will turn ON one PLC cycle later, and the command specified in the DM Area (L) will be processed.
2. When the Transfer Error Flag is turned ON, the error code is present in the DM Area (K).
3. When the Transfer Command Bit is turned OFF, the Transfer Busy Flag and Transfer Error Flag will turn OFF one PLC cycle later.

**Note** In case of an error the Transfer Completion flag is not turned ON.

**Note** For the error codes see section 5-4-7.

**Timing**

The timing is the same as in the case of normal completion.

### 5-4-5 Transfer Timing Chart for Cancelling Processing

The diagram below shows the timing of the Transfer command in case the command is cancelled before completion. The timing is the same for reading and writing.

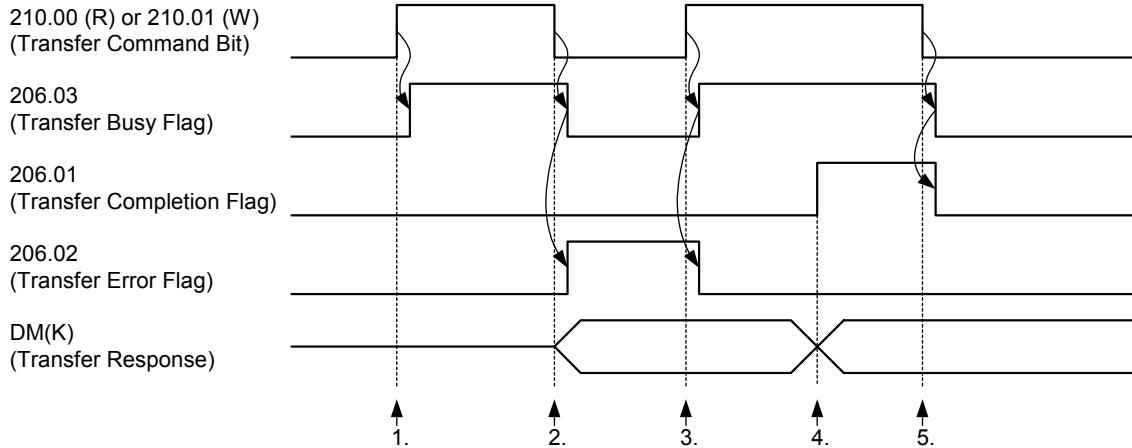

#### Operation

1. When the Transfer Command Bit is turned ON, the Transfer Busy Flag will turn ON, and the command specified in the DM Area (L) will be processed.
2. When the command is cancelled before completion, the Transfer Busy Flag will turn OFF and the Transfer Error Flag will turn ON. The error code (0002) is present in the DM Area (K).
3. When the new Transfer Command Bit is turned ON, the Transfer Busy Flag will turn ON, and the command specified in the DM Area (L) will be processed. The Transfer Error Flag will turn OFF.
4. When the Transfer Completion Flag is turned ON, the response is present in the DM Area (K).
5. When the Transfer Command Bit is turned OFF, the Transfer Busy Flag and Transfer Completion Flag will turn OFF.

### 5-4-6 Transfer Ladder Program

The following ladder program can be used to transfer data from and to the Inverter:

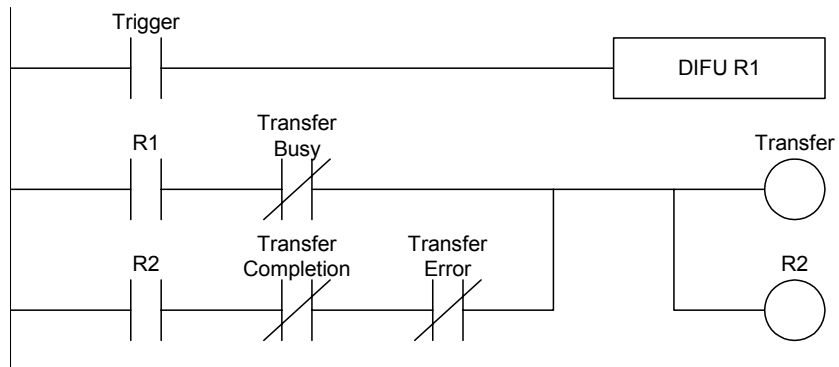

**5-4-7 Transfer Error Codes**

<b>Error code</b>	<b>Name</b>	<b>During reading</b>	<b>During writing</b>
0001	Inverter response error	There was no response from the Inverter.	There was no response from the Inverter.
0002	Command bit OFF during transfer	The command bit turned OFF during transfer execution, and processing was aborted. (Note 1.)	The command bit turned OFF during transfer execution, and processing was aborted. (Note 1.)
0003	Transfer execution while busy	The transfer was executed during busy status.	The transfer was executed during busy status.
0004	Multiple start error	Writing and reading were both activated at the same time	Reading and writing were both activated at the same time
0010	CRC check error	The CRC for the read data did not agree.	The CRC for the response from the Inverter did not agree.
0200	Address error	An unused address was set.	An unused address was set.
0300	Data number error	An attempt was made to read more than 8 registers at the same time.	An attempt was made to write more than 8 registers at the same time
2100	Data setting error	-	The write data is not within the permissible range.
2200	Write error	-	An attempt was made during operation to write a constant that cannot be changed during operation. An attempt was made to overwrite read-only data.
2300	Write error (during UV)	-	An attempt was made to write a constant during UV.
2400	Write error (during processing)	-	An attempt was made to write constants when a write operation was already in progress for the constants.

**Note 1** The situation is the same when the PLC mode is changed during a data transfer, except for cases where the status of output bits is retained when the mode is changed.

**Note** When an error occurs it is not possible to determine exactly up to what point the data was properly received, so the data transfer must be restarted from the beginning.

**Note** When the address K (reserved in DM) is not valid, it is not possible to write the error codes. Hence, only the error bit is set.

**5-4-8 Operations with Command Bit Combinations**

The table below shows the behaviour of the system when a command bit of one type (read or write) is set before clearing the previous command bit of the other type.

	Status			
	Transfer Command Bit 2	Transfer Busy	Transfer Completion	Transfer Error
Transfer Command Bit 1	Busy error occurs. Transfer operation is aborted.	Busy error occurs. Transfer operation is aborted.	Busy error occurs. Command is not executed.	Error is cleared and command is executed.

After the completion of a command the command bit must be cleared first before issuing the next command. Not clearing the command bit has the following consequences:

- Sending a write transfer command immediately after a read transfer command is processed.
- Sending a read transfer command immediately after a write transfer command is not processed.

# Appendix A

## Instructions

The 3G3MV-P10CDT supports 119 basic and special instructions.

### ■ Ladder Diagram Instructions

Name	Mnemonic	Variations
LOAD	LD	---
LOAD NOT	LD NOT	---
AND	AND	---
AND NOT	AND NOT	---
OR	OR	---
OR NOT	OR NOT	---
AND LOAD	AND LD	---
OR LOAD	OR LD	---

### ■ Bit Control Instructions

Name	Mnemonic	Variations
OUTPUT	OUT	---
OUTPUT NOT	OUT NOT	---
SET	SET	---
RESET	RSET	---
KEEP	KEEP(11)	---
DIFFERENTIATE UP	DIFU(13)	---
DIFFERENTIATE DOWN	DIFD(14)	---

### ■ Sequence Control Instructions

Name	Mnemonic	Variations
NO OPERATION	NOP(00)	---
END	END(01)	---
INTERLOCK	IL(02)	---
INTERLOCK CLEAR	ILC(03)	---
JUMP	JMP(04)	---
JUMP END	JME(05)	---

### ■ Timer and Counter Instructions

Name	Mnemonic	Variations
TIMER	TIM	---
COUNTER	CNT	---
REVERSIBLE COUNTER	CNTR(12)	---
HIGH-SPEED TIMER	TIMH(15)	---
ONE-MS TIMER	TMHH(—) <sup>1</sup>	---
LONG TIMER	TIML(—) <sup>1</sup>	---

### ■ Comparison Instructions

Name	Mnemonic	Variations
COMPARE	CMP(20)	---
TABLE COMPARE	TCMP(85)	@
DOUBLE COMPARE	CMPL(60) <sup>1</sup>	---
BLOCK COMPARE	BCMP(68) <sup>1</sup>	@
AREA RANGE COMPARE	ZCP(—) <sup>1</sup>	---
DOUBLE AREA RANGE COMPARE	ZCPL(—) <sup>1</sup>	---

### ■ Data Movement Instructions

Name	Mnemonic	Variations
MOVE	MOV(21)	@
MOVE NOT	MVN(22)	@
BLOCK TRANSFER	XFER(70)	@
BLOCK SET	BSET(71)	@
DATA EXCHANGE	XCHG(73)	@
SINGLE WORD DISTRIBUTE	DIST(80)	@
DATA COLLECT	COLL(81)	@
MOVE BIT	MOVB(82)	@
MOVE DIGIT	MOVD(83)	@

### ■ Shift Instructions

Name	Mnemonic	Variations
SHIFT REGISTER	SFT(10)	---
WORD SHIFT	WSFT(16)	@
ARITHMETIC SHIFT LEFT	ASL(25)	@
ARITHMETIC SHIFT RIGHT	ASR(26)	@
ROTATE LEFT	ROL(27)	@
ROTATE RIGHT	ROR(28)	@
ONE DIGIT SHIFT LEFT	SLD(74)	@
ONE DIGIT SHIFT RIGHT	SRD(75)	@
REVERSIBLE SHIFT REGISTER	SFTR(84)	@
ASYNCHRONOUS SHIFT REGISTER	ASFT(17) <sup>1</sup>	@

### ■ Increment/Decrement Instructions

Name	Mnemonic	Variations
INCREMENT	INC(38)	@
DECREMENT	DEC(39)	@

### ■ Calculation Instructions

Name	Mnemonic	Variations
BCD ADD	ADD(30)	@
BCD SUBTRACT	SUB(31)	@
BCD MULTIPLY	MUL(32)	@
BCD DIVIDE	DIV(33)	@
BINARY ADD	ADB(50)	@
BINARY SUBTRACT	SBB(51)	@
BINARY MULTIPLY	MLB(52)	@
BINARY DIVIDE	DVB(53)	@
DOUBLE BCD ADD	ADDL(54)	@
DOUBLE BCD SUBTRACT	SUBL(55)	@
DOUBLE BCD MULTIPLY	MULL(56)	@
DOUBLE BCD DIVIDE	DIVL(57)	@

**Note 1.** Expansion instructions with default function codes

## ■ Conversion Instructions

Name	Mnemonic	Variations
BCD-TO-BINARY	BIN(23)	@
BINARY-TO-BCD	BCD(24)	@
DOUBLE BCD-TO-DOUBLE BINARY	BINL(58)	@
DOUBLE BINARY-TO-DOUBLE BCD	BCDL(59)	@
DATA DECODER	MLPX(76)	@
DATA ENCODER	DMPX(77)	@
ASCII CONVERT	ASC(86)	@
ASCII-TO-HEXADECIMAL	HEX(— <sup>1</sup> )	@
2'S COMPLEMENT	NEG(— <sup>1</sup> )	@
HOURS-TO-SECONDS	SEC(— <sup>1</sup> )	@
SECONDS-TO-HOURS	HMS(— <sup>1</sup> )	@

## ■ Table Data Manipulation Instructions

Name	Mnemonic	Variations
FRAME CHECKSUM	FCS(— <sup>1</sup> )	@
SUM	SUM(— <sup>1</sup> )	@
DATA SEARCH	SRCH(— <sup>1</sup> )	@
FIND MAXIMUM	MAX(— <sup>1</sup> )	@
FIND MINIMUM	MIN(— <sup>1</sup> )	@

## ■ Data Control Instructions

Name	Mnemonic	Variations
SCALING	SCL(66) <sup>1</sup>	@
SCALING 2	SCL2(— <sup>1</sup> )	@
SCALING 3	SCL3(— <sup>1</sup> )	@
PID CONTROL	PID(— <sup>1</sup> )	---
AVERAGE VALUE	AVG(— <sup>1</sup> )	---

## ■ Logic Instructions

Name	Mnemonic	Variations
COMPLEMENT	COM(29)	@
LOGICAL AND	ANDW(34)	@
LOGICAL OR	ORW(35)	@
EXCLUSIVE OR	XORW(36)	@
EXCLUSIVE NOR	XNRW(37)	@

## ■ Special Calculation Instructions

Name	Mnemonic	Variations
BIT COUNTER	BCNT(67) <sup>1</sup>	@

## ■ Subroutine Instructions

Name	Mnemonic	Variations
SUBROUTINE CALL	SBS(91)	@
SUBROUTINE ENTRY	SBN(92)	---
SUBROUTINE RETURN	RET(93)	---
MACRO	MCRO(99)	@

## ■ Interrupt Control Instructions

Name	Mnemonic	Variations
INTERRUPT CONTROL	STIM(69) <sup>1</sup>	@
INTERVAL TIMER	INT(89) <sup>1</sup>	@

## ■ Pulse Control Instructions

Name	Mnemonic	Variations
MODE CONTROL	INI(61) <sup>1</sup>	@
HIGH-SPEED COUNTER PV READ	PRV(62) <sup>1</sup>	@
REGISTER COMPARISON TABLE	CTBL(63) <sup>1</sup>	@

## ■ Pulse Output Control Instructions

Name	Mnemonic	Variations
SPEED OUTPUT	SPED(64) <sup>1</sup>	@
SET PULSES	PULS(65) <sup>1</sup>	@
PULSE W/ VARIABLE DUTY	PWM(— <sup>1</sup> )	@
RATIO		
ACCELERATION CONTROL	ACC(— <sup>1</sup> )	@
SYNCHRONIZED PULSE CONTROL	SYNC(— <sup>1</sup> )	@

## ■ I/O Unit Instructions

Name	Mnemonic	Variations
7-SEGMENT DECODER	SDEC(78)	@
I/O REFRESH	IORF(97)	@

## ■ Communications Instructions

Name	Mnemonic	Variations
RECEIVE	RXD(47) <sup>1</sup>	@
TRANSMIT	TXD(48) <sup>1</sup>	@
CHANGE RS-232C SETUP	STUP(— <sup>1</sup> )	@

## ■ Step Instructions

Name	Mnemonic	Variations
STEP DEFINE	STEP(08)	---
STEP START	SNXT(09)	---

## ■ User Error Instructions

Name	Mnemonic	Variations
FAILURE ALARM AND RESET	FAL(06)	@
SEVERE FAILURE ALARM	FALS(07)	---

## ■ Display Instructions

Name	Mnemonic	Variations
MESSAGE DISPLAY	MSG(46)	@

## ■ Carry Flag Instructions

Name	Mnemonic	Variations
SET CARRY	STC(40)	@
CLEAR CARRY	CLC(41)	@

**Note 1.** Expansion instructions with default function codes.



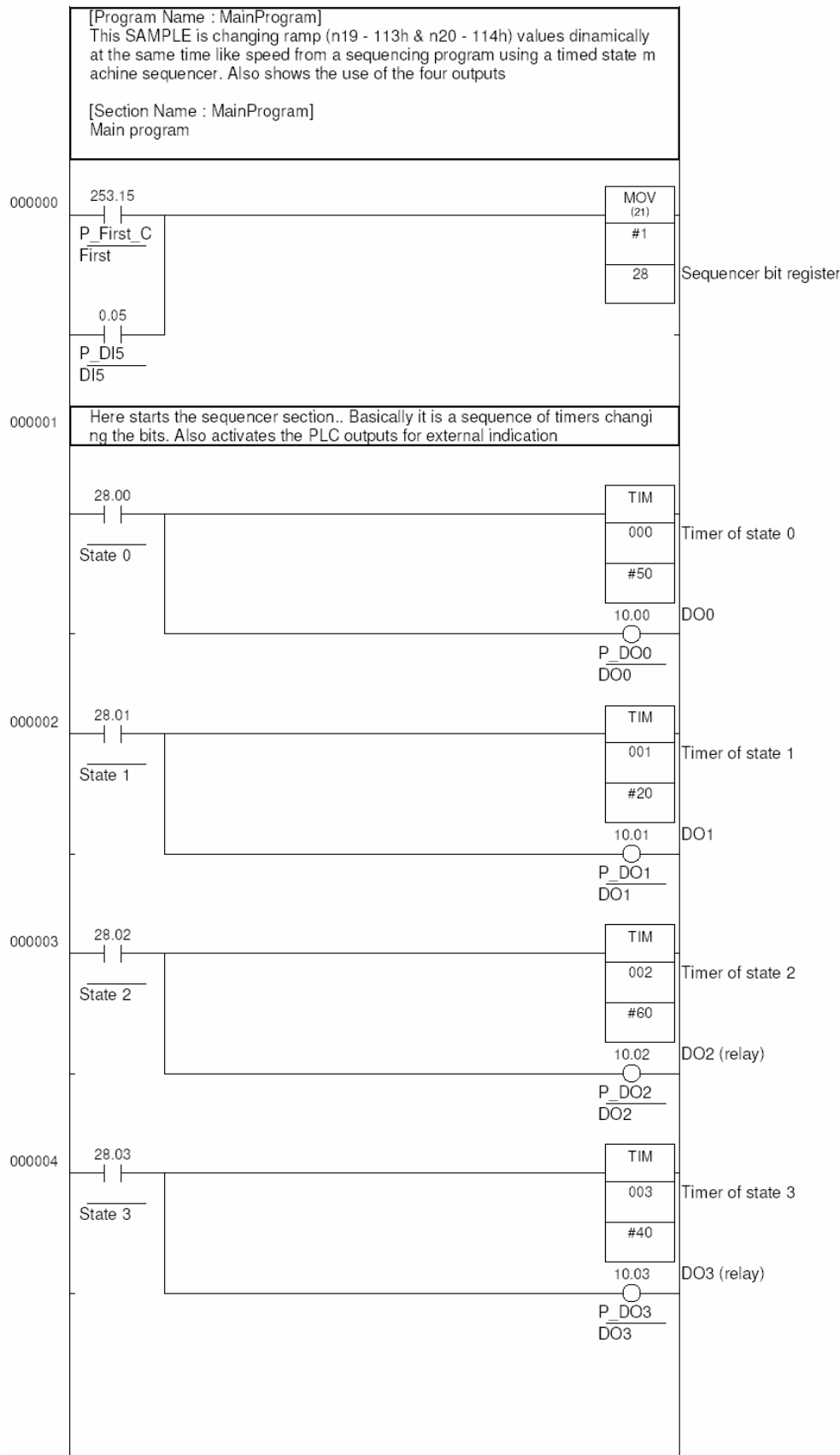

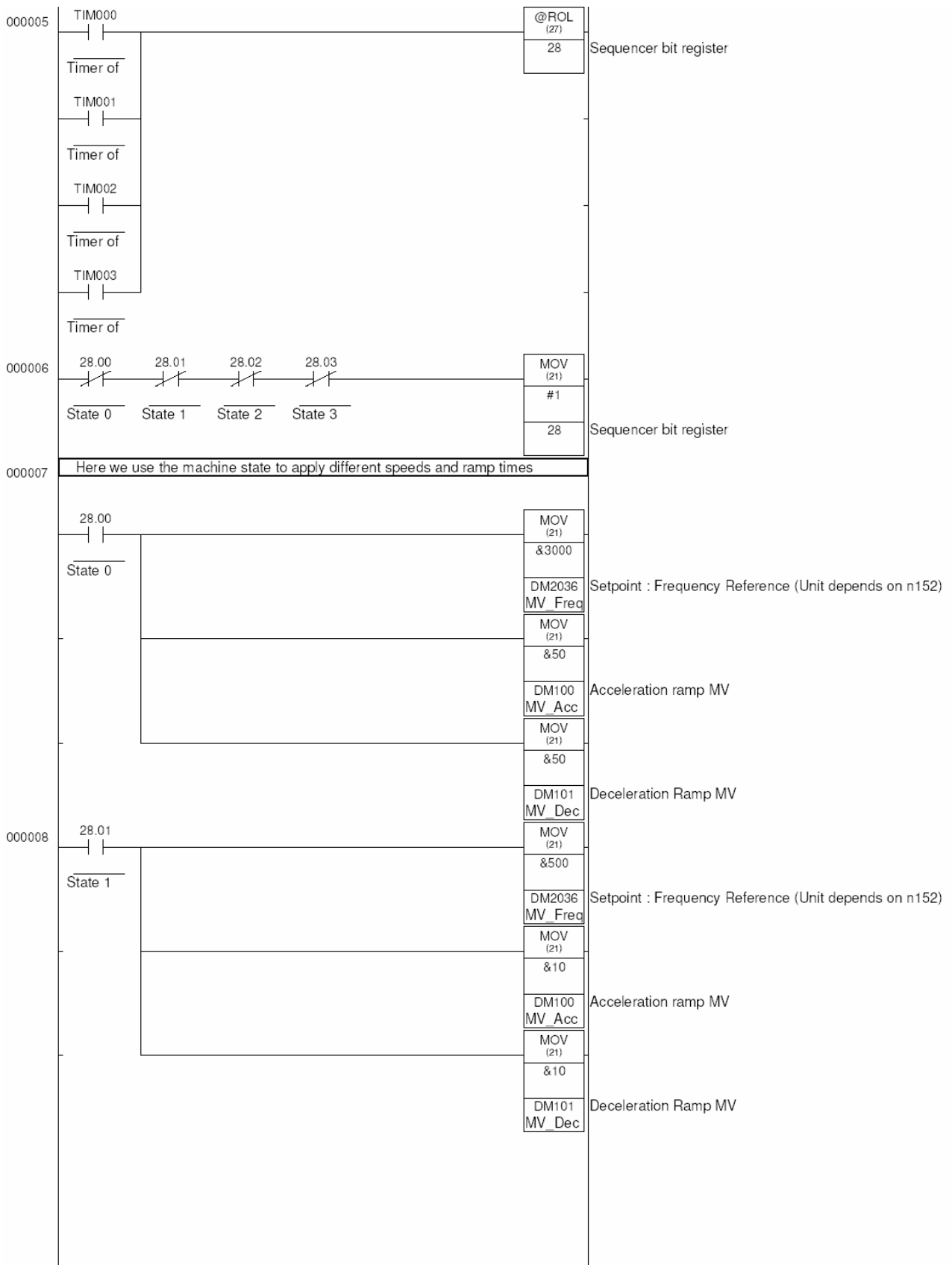

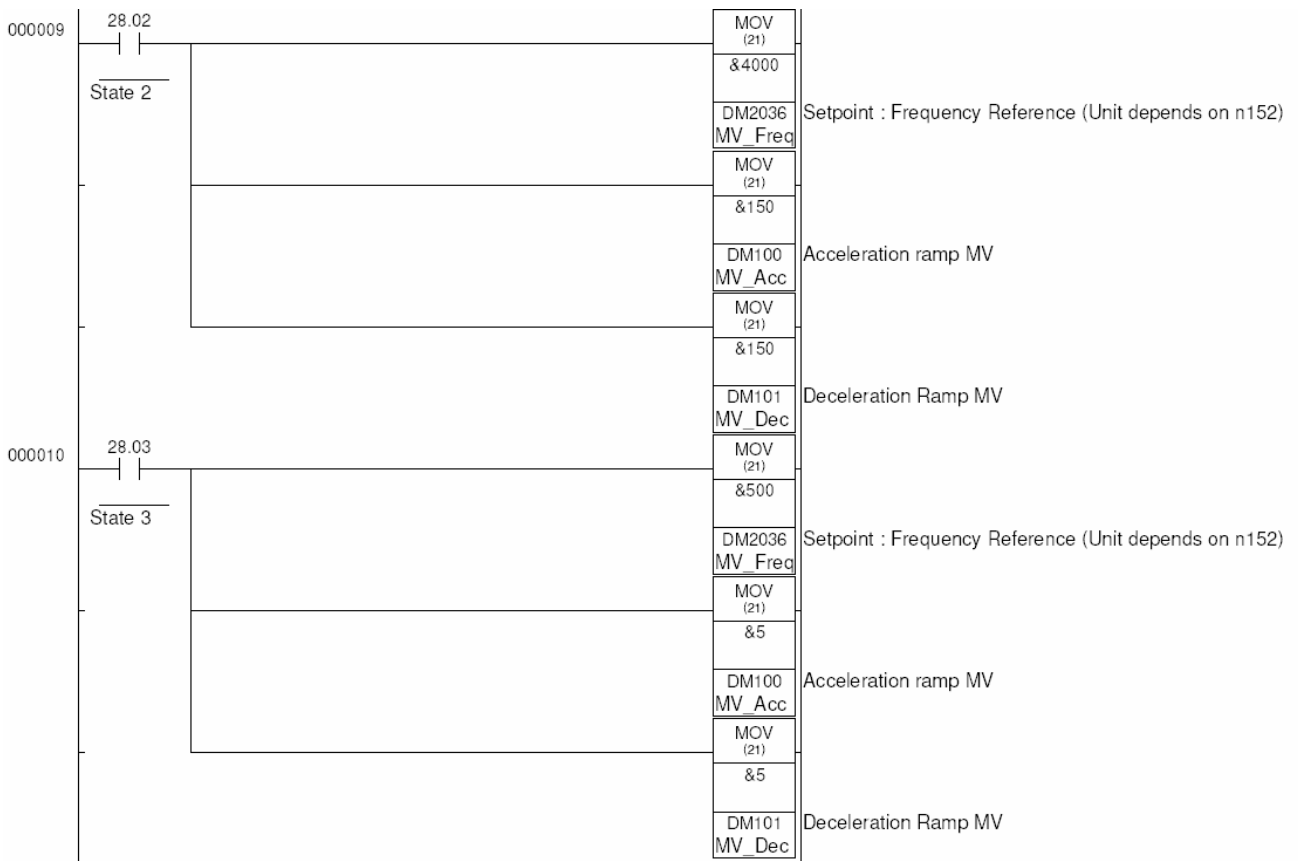

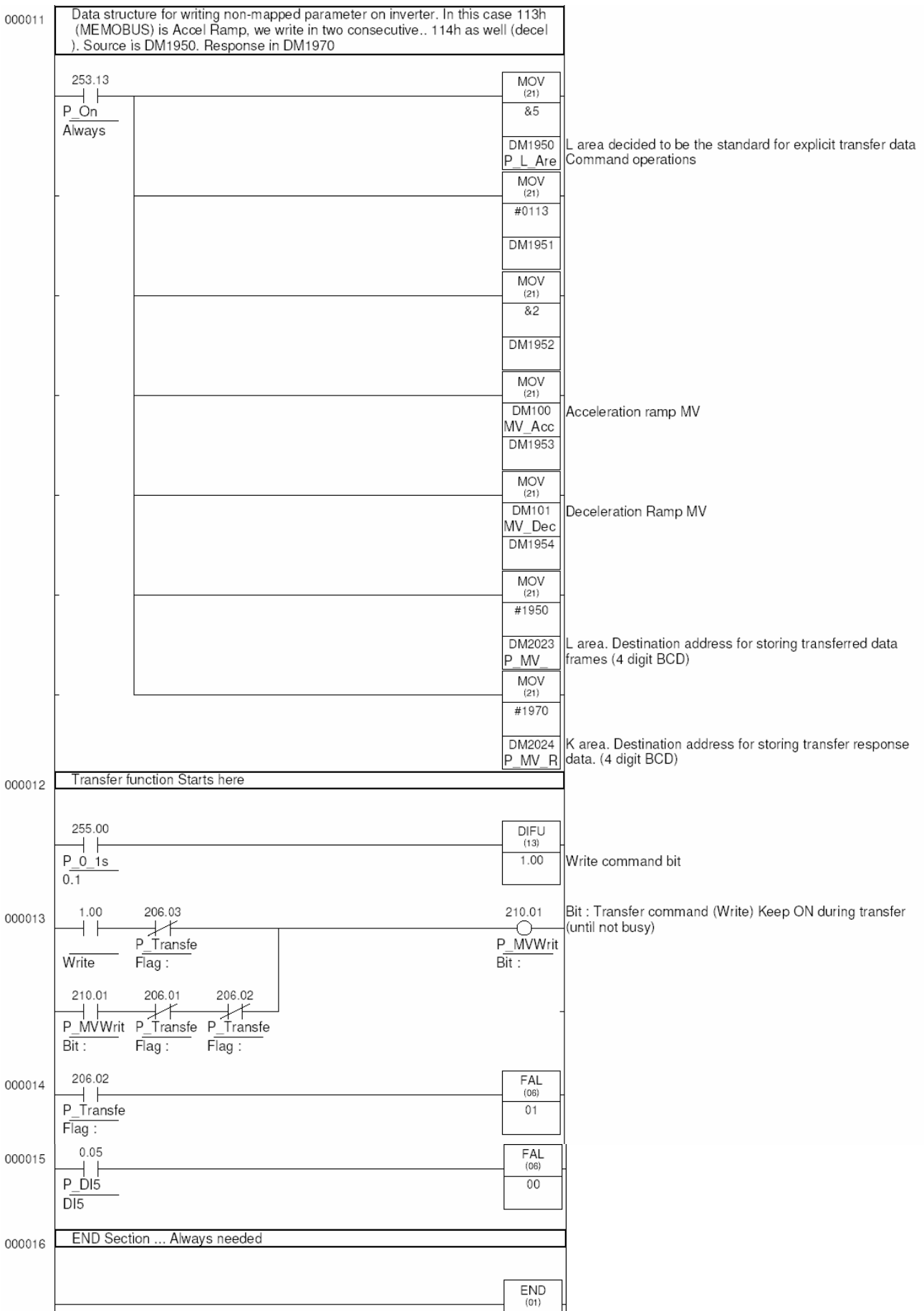

### B-3 Basic Read Parameter template program

This SAMPLE is reading torque monitor of MV (32h) value. Only Vector. It writes in DM101 as BCD. Compare with DM2026... Although the selection of the transfer zones is free for the user, it is recommended to follow the recommendations..

PARAMETER	Type	Description	Recommended
210.00	BIT R/W	Transfer (Read) (ON: Begin Reading; turns OFF when transfer is completed.)	0
210.01	BIT R/W	Transfer (Write) (ON: Begin writing; turns OFF when transfer is completed.)	0
206.00	BIT R/W	Inverter Ready (error detected by mutual diagnosis) (ON: Normal; OFF: Error)	0
206.01	BIT R/W	Transfer completion bit (ON: Transfer completed; turns OFF when TRANSFER command turns OFF.)	0
206.02	BIT R/W	Transfer error (ON: Error; OFF: Normal)	0
206.03	BIT R/W	Transfer busy (ON: Busy; OFF: Ready for transfer)	
DM2023	WORD R/W BCD	Destination address for storing transferred data (4 digits BCD): L . We recommend using DM1950	1950
DM2024	WORD R/W BCD	Destination address for storing transfer response data (4 digits BCD): K . We recommend using DM1970	1970

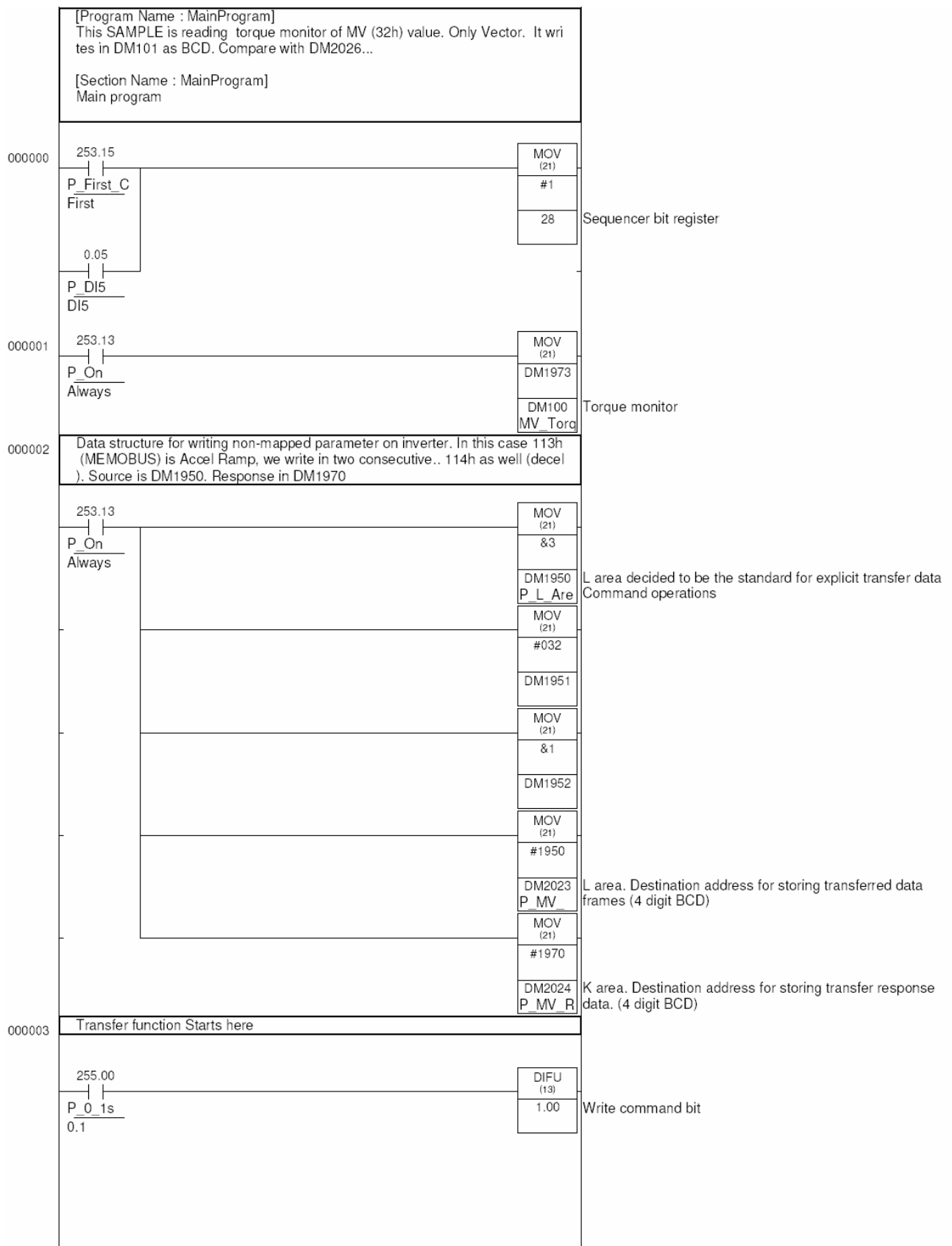

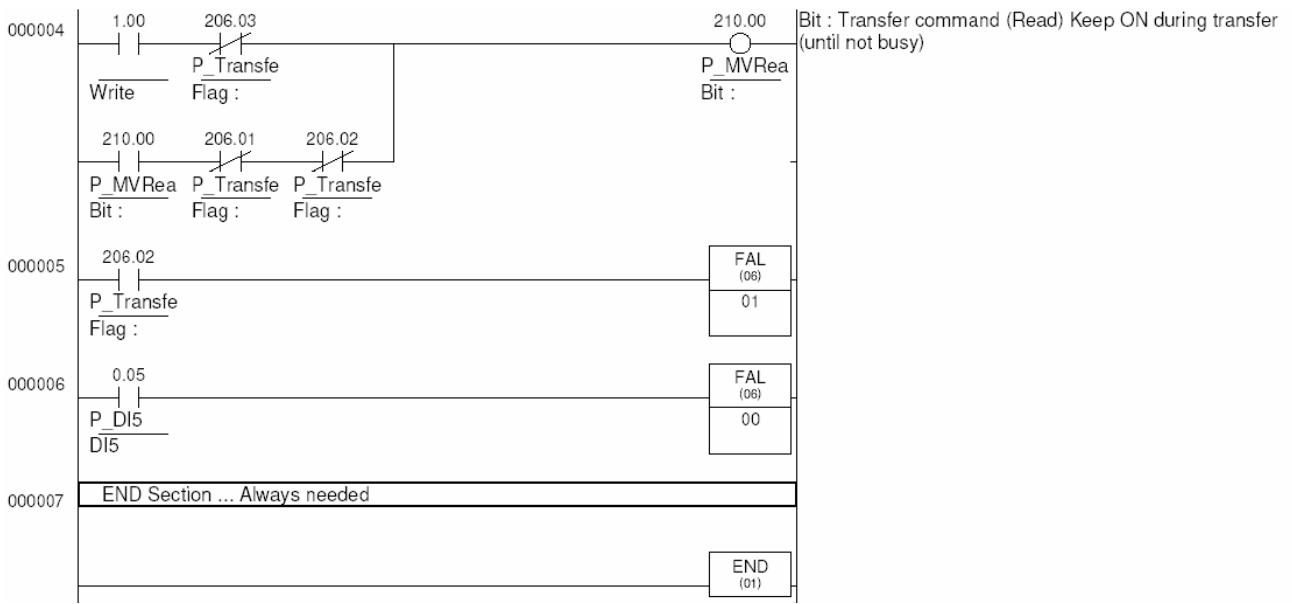

## B-4 Basic Positioning template program

The PLC option board for 3G3MV inverters provides the needed hardware to perform a basic position control software. We can read an encoder with A and B phase signals, digital inputs and have complete control on the inverter speed and Run commands. We have additional I/O and fully programmable PLC. That's all needed for a position controller application.

The control loop is performed by the ladder program. The selected control loop performs a very simple P controller on the position error between demanded and real positions.. Then it limits and applies a frequency reference proportional to it. With this setup, without profile generator (acceleration, deceleration generated by position reference calculations), we have a compact position controller software, that will solve a lot of simple point to point applications.

### B-4-1 Method

- We apply directly the position difference as speed reference , we have programmed some acceleration on the inverter (so it will ramp up at that defined rate). The inverter has zero deceleration, so when the position is reaching the point automatically the speed is reduced gradually, generating some non-linear ramp, but stopping in the correct position.
- As the PLC can not handle big negative numbers we have to apply an offset position and work around an intermediate point, scaling for the user.

### B-4-2 Features

- Easy to use
- Continuous loop
- Scaled setpoint by N1/N2 factor.
- 2 InPosition windows. The second one can be defined bigger for faster sequence control.
- Variable P Gain
- Position\_Reset available
- Home(origin) search sequence, with fast forward and slow backwards seek. Definable speeds
- Home(origin) timeout control

### B-4-3 Limitations

- As the 3G3MV is an open loop inverter, with only P type of controller, inertial loads might not be well handled by the software, leading to oscillation. Lowering P gain can help, but lowers dynamics. It is preferred some kind of frictional load. Most applications that use a high gear-ratio gear-motor will be mostly controlled. To control inertial loads a more sophisticated control loop should be programmed. Using a free motor can lead to instability.
- Deceleration profile will be exponential due to the method of using the position difference to generate speed reference.
- We are limited to two word position references. So 80000000 quadrature pulses approximately.
- The values allowed for the fractional factor limit the reference position range. Scaling intermediate results can only be two word values. The bigger the factor, the shortest the position reference allowed. It is recommended to use values from 1 to 10 in N1 and N2.
- We don't have the real concept of following error as the program does not perform a real positioning profile. We only have the "demanded-real position" error.

### B-4-4 Inverter/PLC Setup

We need some specific settings in the inverter for a correct positioner work :

- We will use two sets of ramps... one is for the positioning with acceleration defined and deceleration set to zero...
- n021=1 sec n022=0 sec for position control (n022 must be always zero).

- The other will be used in speed control mode, where we require both acceleration and deceleration to be active...
- n019=2 sec n020=2 sec for speed control or any desired.
- n54=11 (accel/deccel change by S5 or internally controlled by PLC) To allow the program to do the changeover automatically. The PLC will simulate that input by 207.04 control bit
- It is recommended a modified VF curve for better response in the lower frequency range ... Typically for Vector values like following are good initial values :
- n015=30V, n016 = 0.1Hz , n017=15Hz
- Keep n35=0 (0.01Hz resolution of speed references) for better resolution in speed control.

We also need particular settings in the PLC side :

In the PLC, following bits have to be cleared : IR209.00=0 and IR209.01=0. In this way we provide full Speed reference and Run command control from the PLC regardless the inverter settings.

And the configuration for the input encoder (24Vdc type).

For the counter to work with the encoder we need following settings :

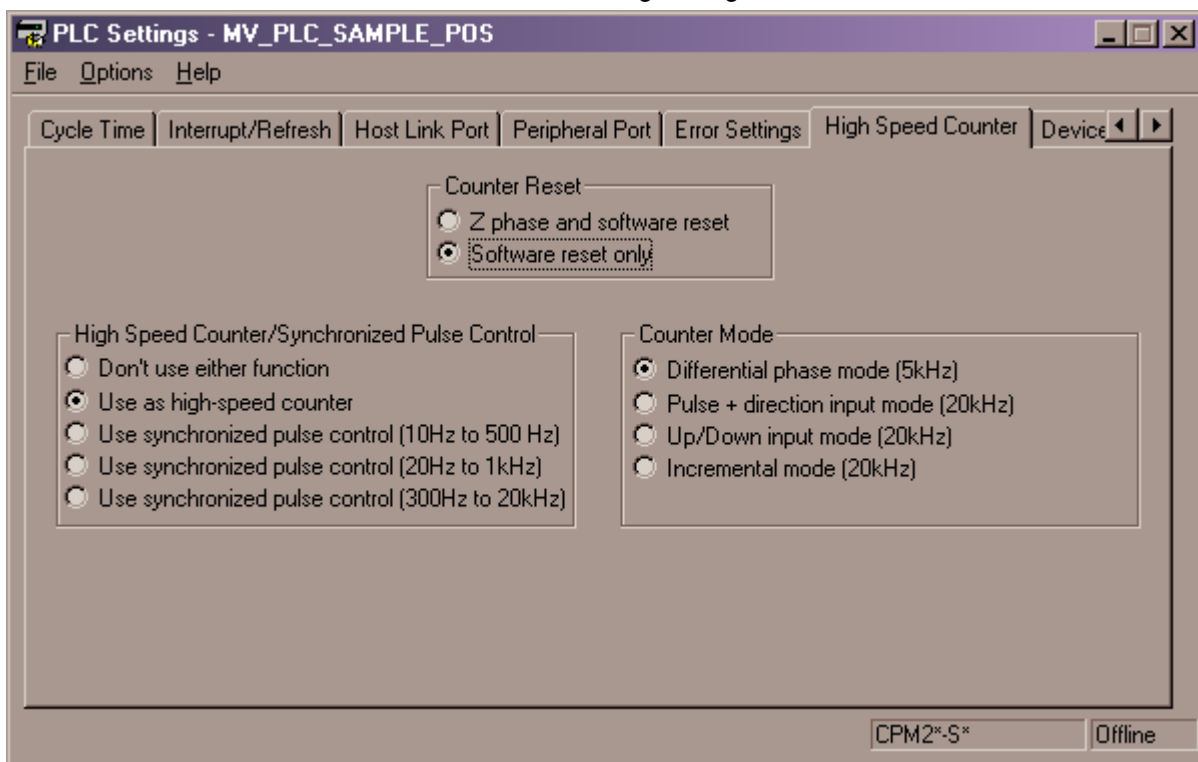

### B-4-5 I/O Connections

In the template following basic inputs are predefined :

**PLC Input 0** : A Channel encoder

**PLC Input 1** : B Channel encoder

**PLC Input 2** : Home/Origin sensor

Then the user program can use the rest of PLC and inverter inputs ...

In our Application example we use :

**PLC Input 3** for Home/Origin request and

PLC Input 4 for positioning

## B-4-6 Defining the application

- When counting for the required accuracy a safe rule is to count on 20-30 quad edge pulse error directly on the motor. Depends mostly on the mechanical system design.
- The encoder can be either in the motor or after gearbox. For higher accuracy in the motor is good, but then we have to be careful with the frequency limits of the input.
- In any case take into account the 5KHz maximum input rate for the maximum motor speed. Depends on the encoder resolution, where it is placed and encoder max rpm. Typical figure is for a 1500rpm motor, with encoder directly coupled to motor that we can use a 200ppr encoder if we require full speed range : This is 5KHz at top speed.

## B-4-7 Program structure

The program structure is as follows:

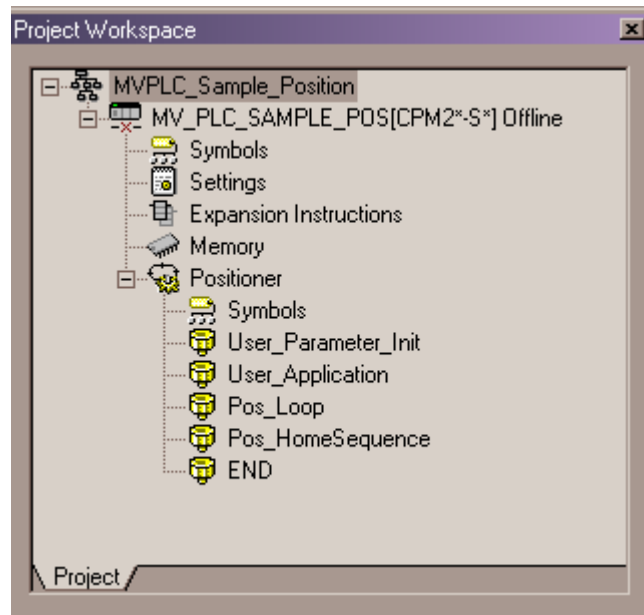

- **User\_Parameter\_Init:** will be used by the customer to initialise Position program parameters and application own parameters
- **User\_Application:** will make use of the control bits and parameters of the Positioning template to do the machine sequence. If the user program has more sections all have to be in front of the Pos\_??? sections.
- **Pos\_Loop:** provides the position/speed control capabilities
- **Pos\_HomeSequence:** provides the home sequence facilities.

## B-4-8 Setting position parameters

The software provides the following BIT/WORD interface area and default values ....

NOTE : as the reading of the encoder signal comes from quadrature signals, the name quads refers to four counts for each encoder pulse.... It means a 200ppr encoder will provide a real resolution of 800 quads per revolution....

The frequency limit is defined by the real pulse limit, not quads.

**Default values** are the default values in the examples provided. Customer can fill its own values.

It is recommended to first do a trial run in speed with small reference and check that the counting of the encoder corresponds to speed reference given. If not some wiring might be wrong. Once positive sense corresponds to positive count, then we can go for the positioner settings.

Parameter	Type	Description	Default Value
2.00	BIT (R/W)	Control_Mode : 0=Speed, 1=Position	0
2.01	BIT (R/W)	Position_Reset : 1=reset . Use with SET. Resets to zero when done	0
2.02	BIT (R/W)	Home_Request : 1=Home is requested. The sequence begins. Once finished we can have either 3.00=1 (Home_OK) or 3.01=1 (Home_Error). The maximum time to perform home is defined in DM32	0
2.03	BIT (R/W)	Speed_Run_Fwd : In Speed mode (2.00=0), it generates Run forward of the inverter with 2.03=1. The speed reference from DM2036. 209.00=0 and 209.01=0 for full PLC control.	0
2.04	BIT (R/W)	Speed_Run_Rev : Like 2.03, but in reverse direction	0
3.00	BIT (R)	Home_OK : When home is finished and OK, this bit is activated	--
3.01	BIT (R)	Home_Error : If home is not finished in the defined timeout DM32, then Home_Error appears and the sequence is cancelled.	--
3.02	BIT (R)	In_Position1 : The finest in position. Defined window in DM16. Used for the positioner work itself.	--
3.03	BIT (R)	In_Position2 : Available for fastest sequence work. We define in DM18. Typically used to start processes slightly before the final position is reached (activate a valve, move other axis, etc.).	--
DM10	DWORD (R/W) BCD	SP : BCD. SetPoint of position (in units) DM10 and DM11	0
DM12	DWORD (R/W) BCD	SP_PV_Scale_N1 : Numerator of SP&PV scaling	1
DM14	DWORD (R/W) BCD	SP_PV_Scale_N2 : Denominator of SP&PV scaling  Scaling is .. units * $\frac{N1}{N2}$ = quads  Default values correspond to direct quad control	1
DM16	DWORD (R/W) BCD	In_Position1_Window : Defines the width of the In_Position output 1. This has to be the most accurate positioning window. Usually just some units. In units	2
DM18	DWORD (R/W) BCD	In_Position2_Window : Defines a wider window for use in the software sequence (start some actions just while the movement is being finished). In quads	20
DM20	DWORD (R/W) BCD	Home_Initial_Pos : In units. Defines the initial movement to an initial position <>0 after the homing process has been defined.	0
DM22	DWORD (R/W) Decimal	Max_Frequency : Value in speed units from the inverter (depends on n035). We recommend n035 to leave standard (0) so we have the best resolution (0.01Hz).	2000
DM24	DWORD (R/W) BCD	P_Gain : This is the factor that will generate the final speed reference from the position error quads. If it is too big we will have overshoot. If too low, positioning will be slow. If we have big inertia it might happen that even with small gain we have instability.	10

PARAMETER	Type	Description	Default Value
DM26	DWORD (R/W) BCD	Max_Pos_Error : This limits the error output. This is necessary mainly for calculation limit issues.	10000
DM28	DWORD (R/W) BCD	PV_Rotary_Scale : This is an additional "Present Value" readout that shows in DM44 (Dword) Whole DM28 groups of counts and in DM46 (Dword) the remaining in one "wrap around count". If we use a scaling for degrees and DM28 is 360, then is just turns/degrees idea.	360
DM30	DWORD (R/W) Decimal	Home_Fast_Speed : This is the first speed used to find the home/origin sensor in reverse sense. Decimal value in units defined by n035. By default 0.01Hz	50
DM31	DWORD (R/W) Decimal	Home_Seek_Speed : Once found the sensor, forward seek at this speed is performed until the sensor disappears. This ensure accurate homing. Decimal value in units defined by n035. By default 0.01Hz	20
DM32	DWORD (R/W) BCD	Home_Process_MaxTime : Timeout value in 0.1 sec unit. This is the allowed time for the homing process to finish.	150
DM2036	DWORD (R/W) Decimal	MV_Freq_Ref_Set : This is the speed reference when the PLC is controlling the inverter. In position mode (2.0=1) The program generates automatically this reference. In speed mode (2.0=0) the user has to set the value to control the speed.	100
DM40	DWORD (R) BCD	PV_Final : Scaled Present Value. Real position read from the encoder. Scaling factors to/from quads in DM12 / DM14	--
DM44	DWORD (R) BCD	PV_Whole_Turns : Scaled PV with "wrap around" function from DM28	--
DM46	DWORD (R/W) BCD	PV_Angular_Position : Scaled PV with "wrap around" function from DM28	--

Have a look to the simple **User\_Application** section to check how simple it is to use the positioner program.

### B-4-9 Programs

#### User\_Parameter\_Init

000000	[Program Name : User_Parameter_Init] Sample for positioning control	
	[Section Name : User_Parameter_Init] OYMC 2003	
	This section initializes positioner parameters to some default values. Scaling is in pulses directly 1/1	
	253.15	
	P_First_C	MOV (21)
	First	#0
		DM17 In_Positi
		MOV (21)
		#2
		DM16 In_Positi
		MOV (21)
		#0
		DM19 In_Positi
		MOV (21)
		#20
		DM18 In_Positi
		MOV (21)
		#1
		DM12 SP_PV
		MOV (21)
		#0
		DM13 SP_PV
		MOV (21)
		#1
		DM14 SP_PV
		MOV (21)
		#0
		DM15 SP_PV
		MOV (21)
		#20
		DM24 P_Gain_i
		MOV (21)
		#2000
		DM22 Max_Fre

	MOV (21)	
	#0	
	DM23 Max_Fre	Max_Frequency High word
	MOV (21)	
	#0	
	DM26 Max_Po	Max_Pos_Error
	MOV (21)	
	#1	
	DM27 Max_Po	Max_Pos_Error High word
	MOV (21)	
	#360	
	DM28 PV_Rota	PV Scale for rotary wrap
	MOV (21)	
	#0	
	DM29 PV_Rota	PV Scale for rotary wrap high word
	MOV (21)	
	#0	
	DM20 Home_In	Position to move after home finished.
	MOV (21)	
	&50	
	DM30 Home_F	Speed reference for the fast homing approach. Search for sensor
	MOV (21)	
	&20	
	DM31 Home_S	Speed reference for the second home phase. Slow release of sensor
	MOV (21)	
	#150	
	DM32 Home_P	Max time allowed for homing process. If exceeded then Home_Error is active and process cancelled.

User\_Application

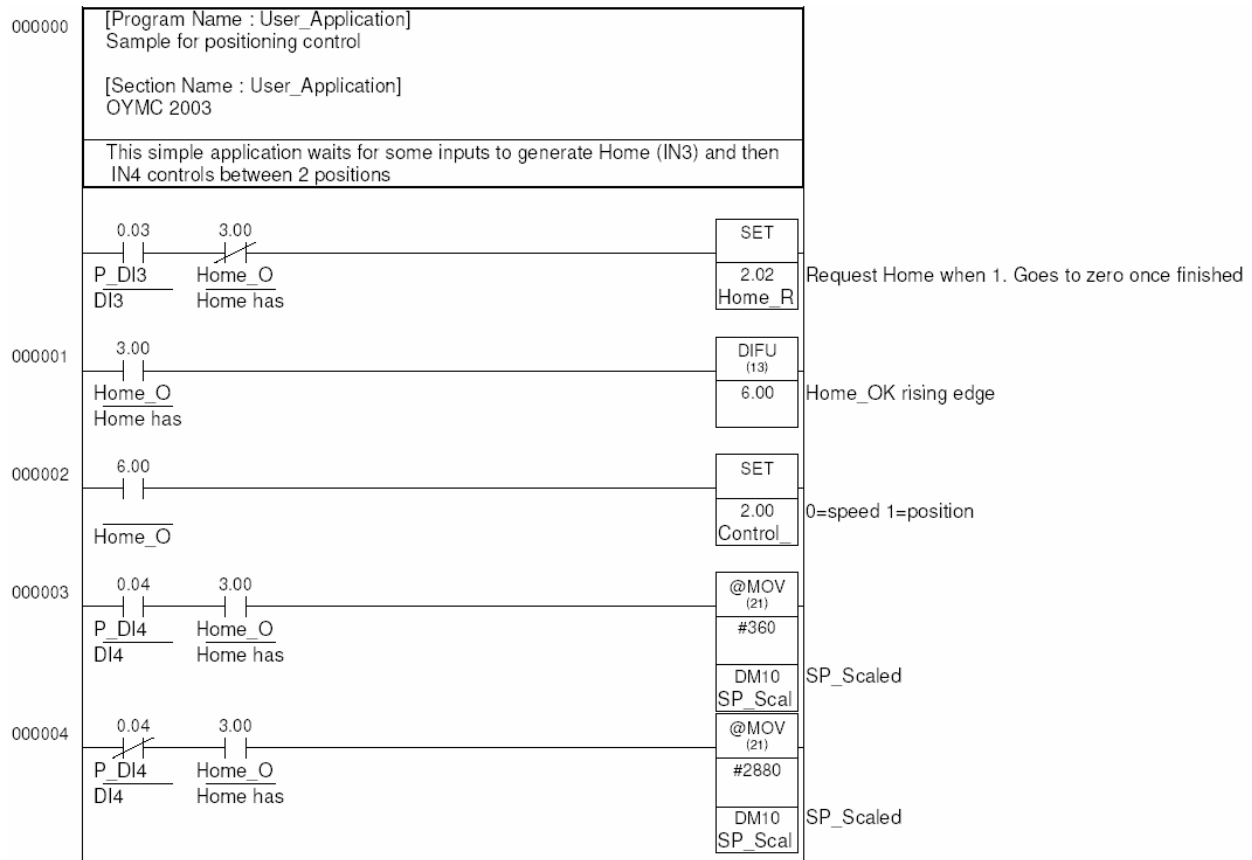

Pos\_Loop

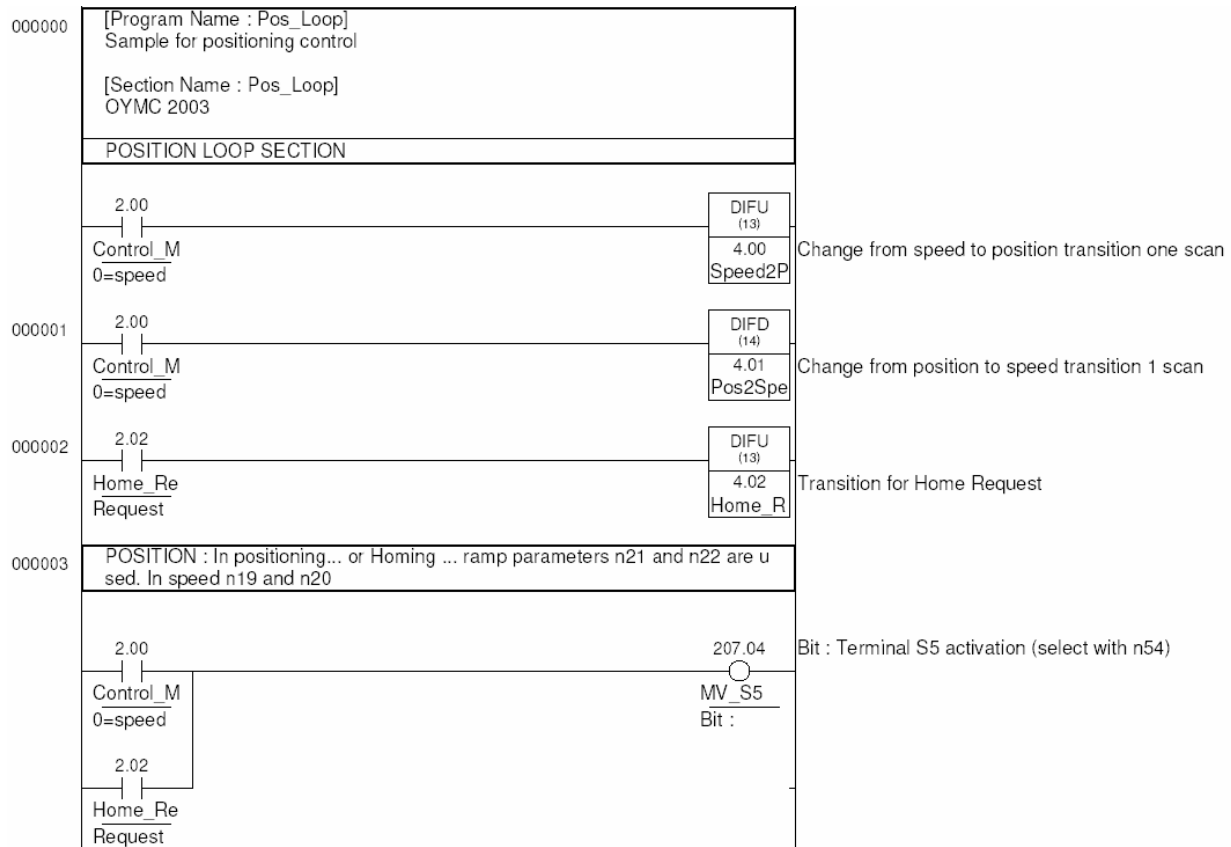

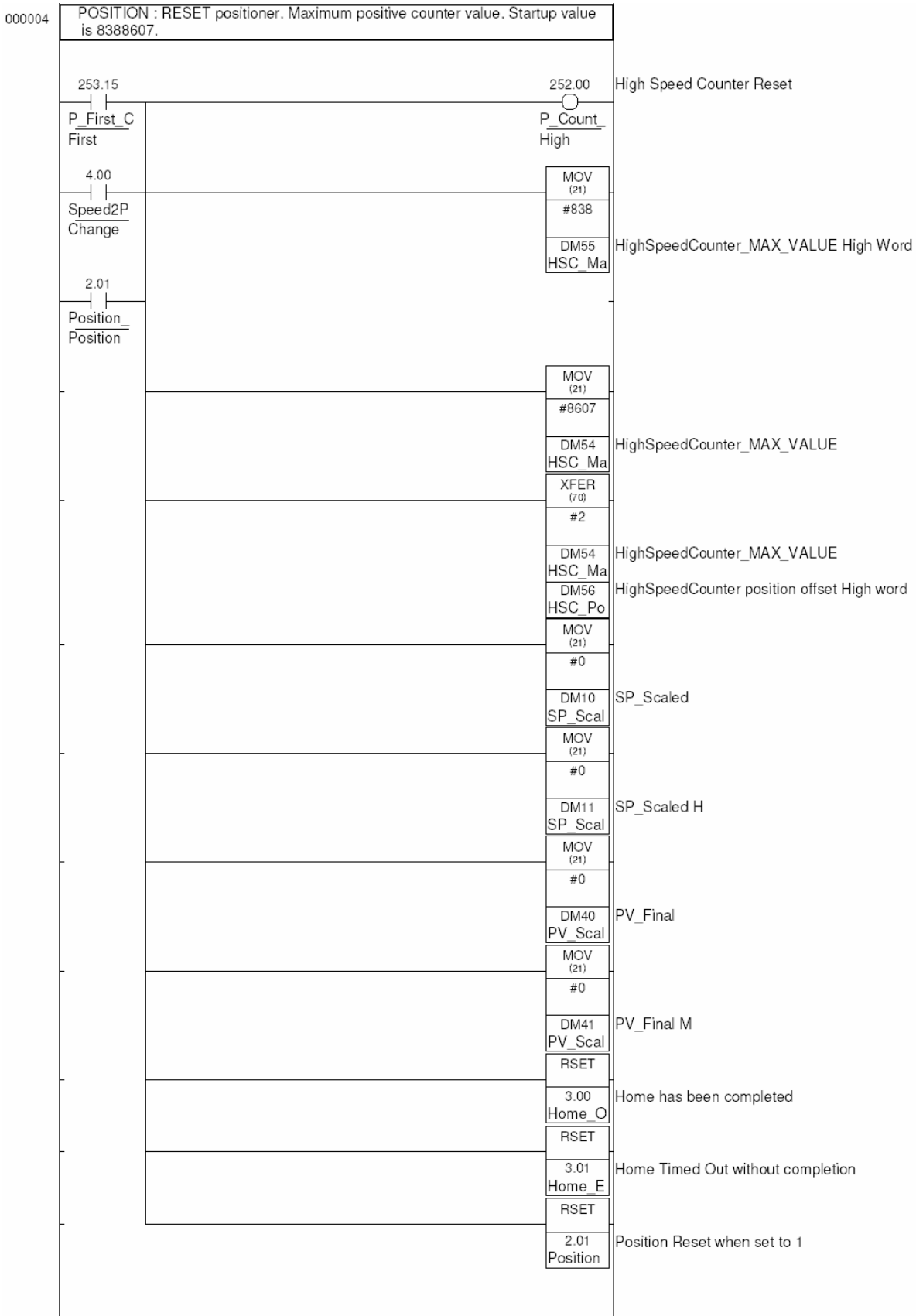

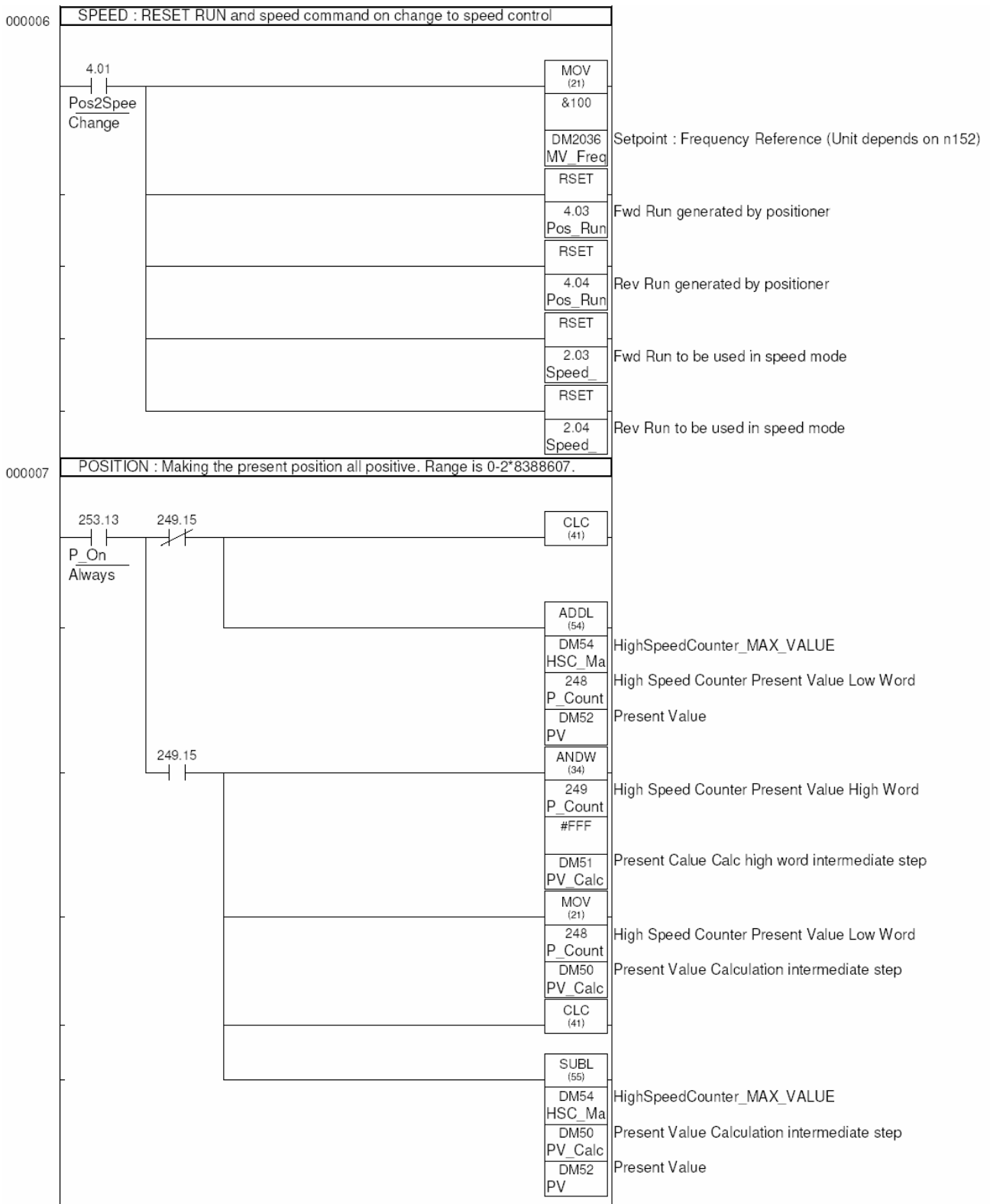

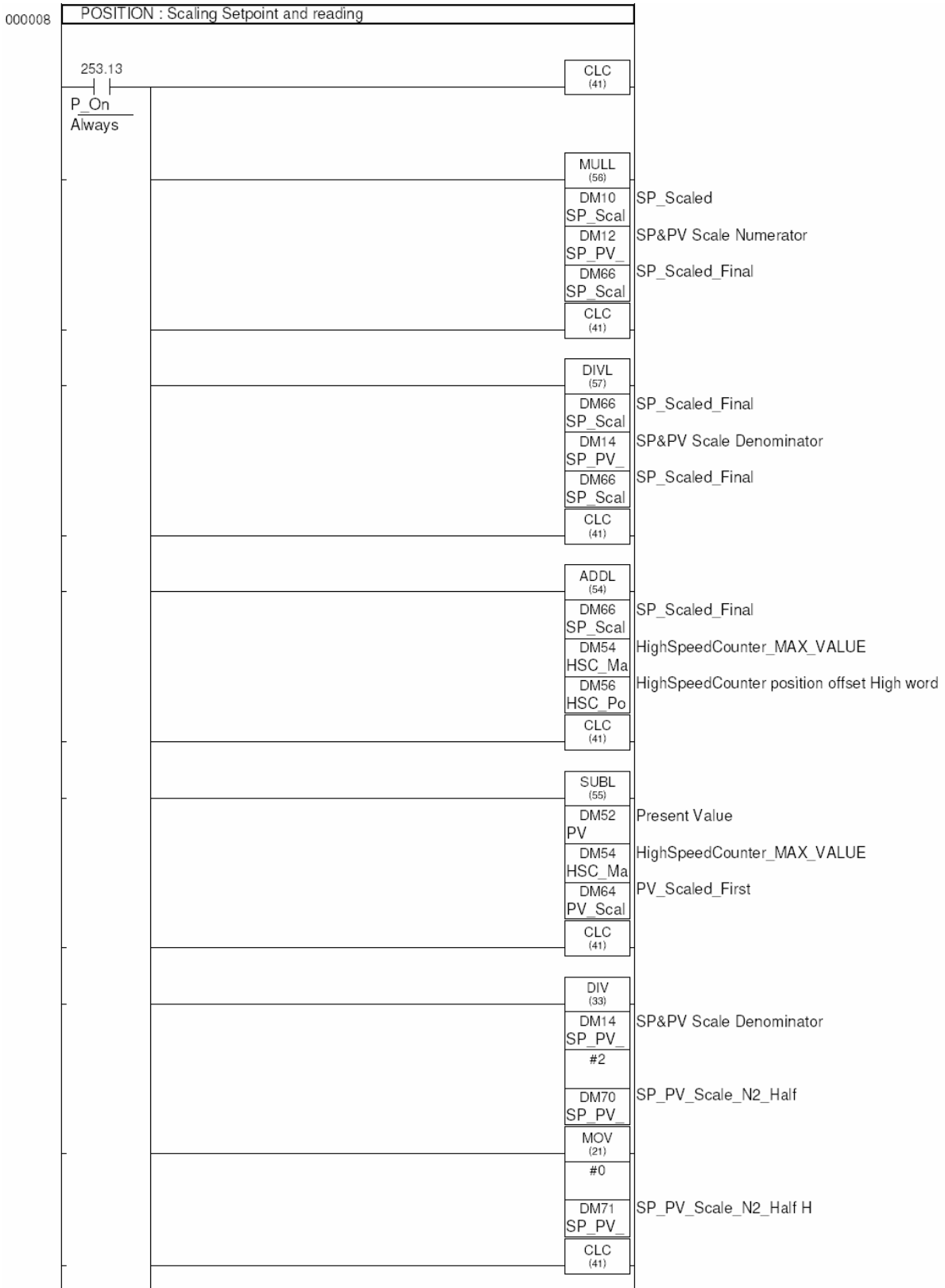

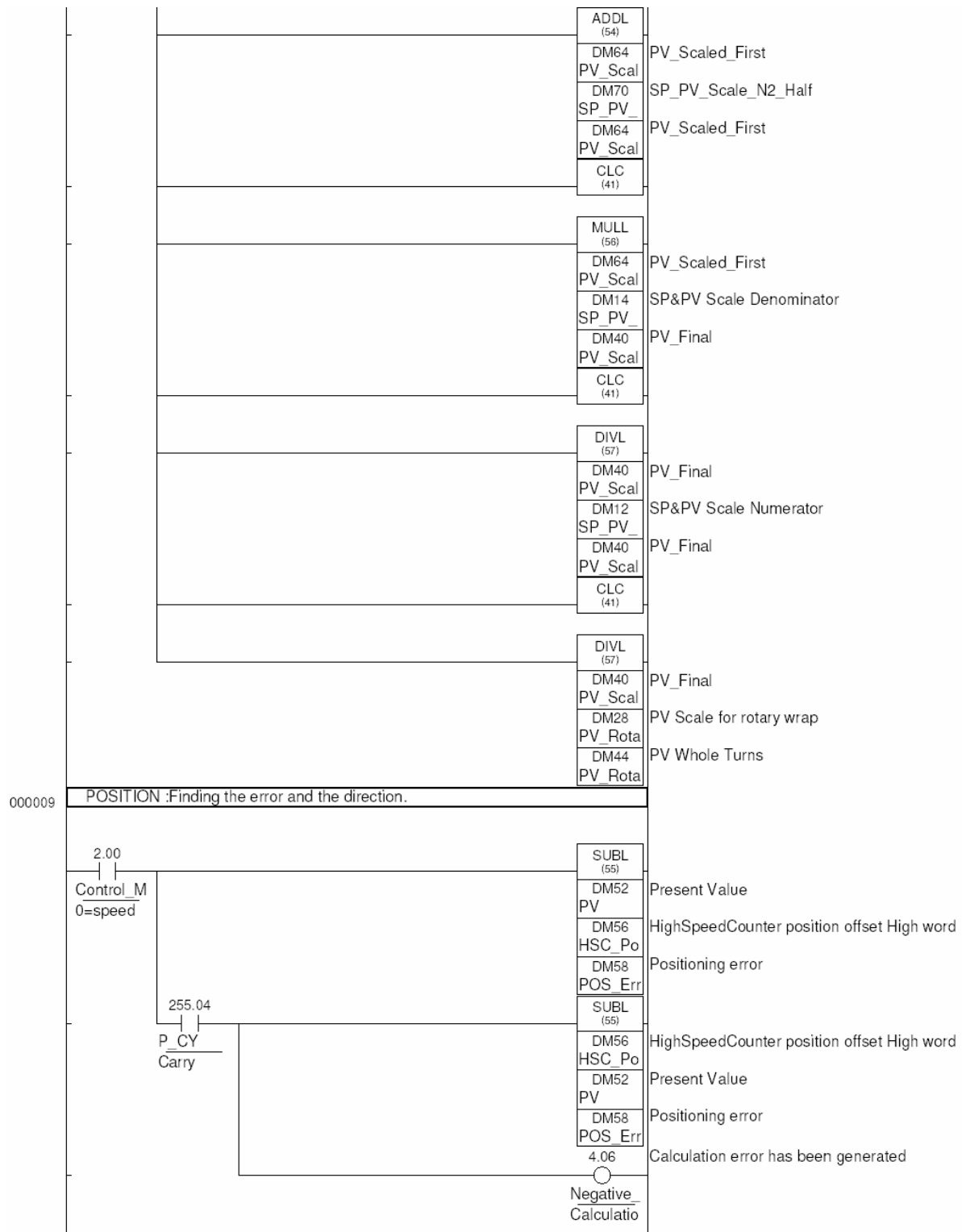

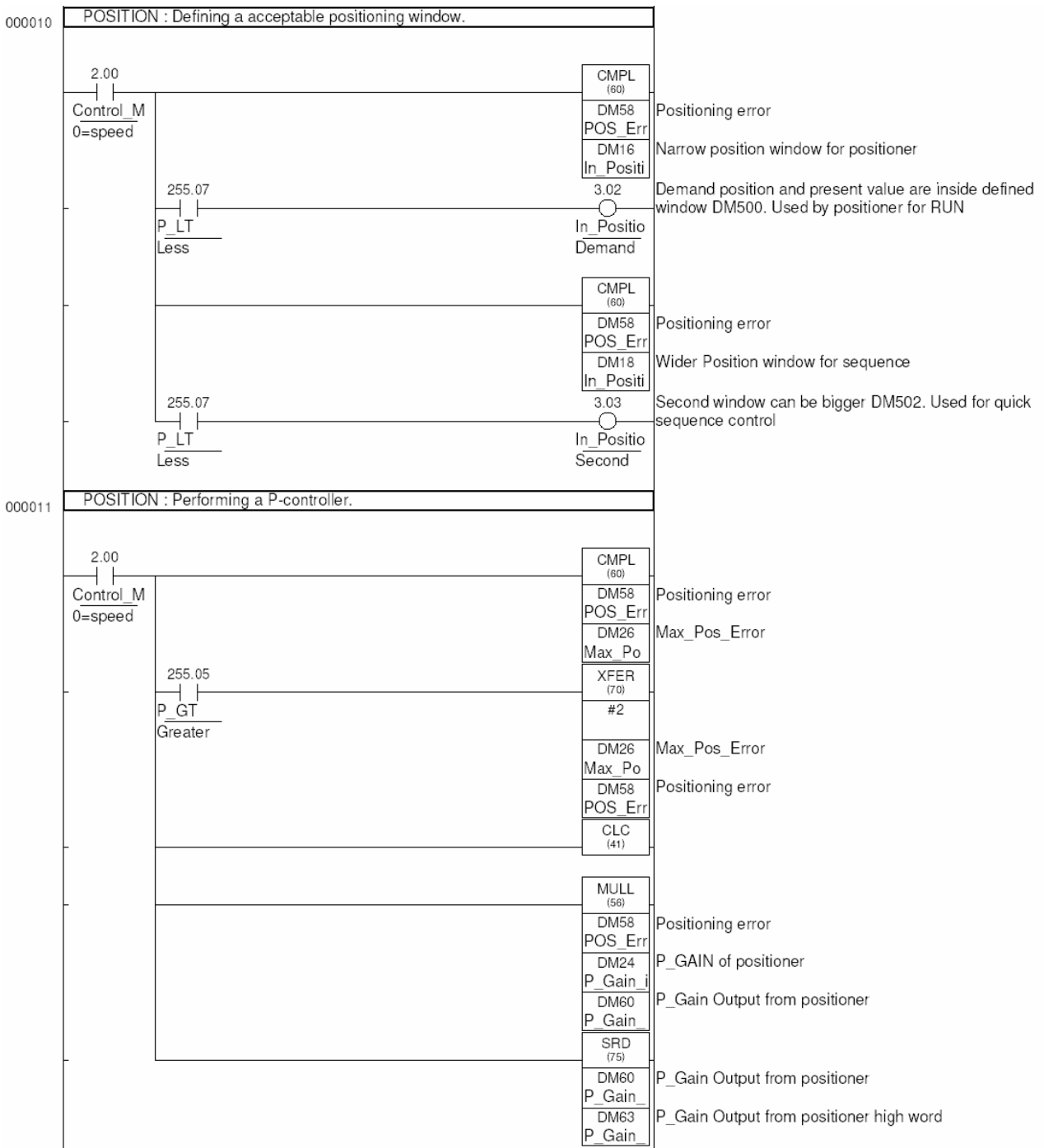

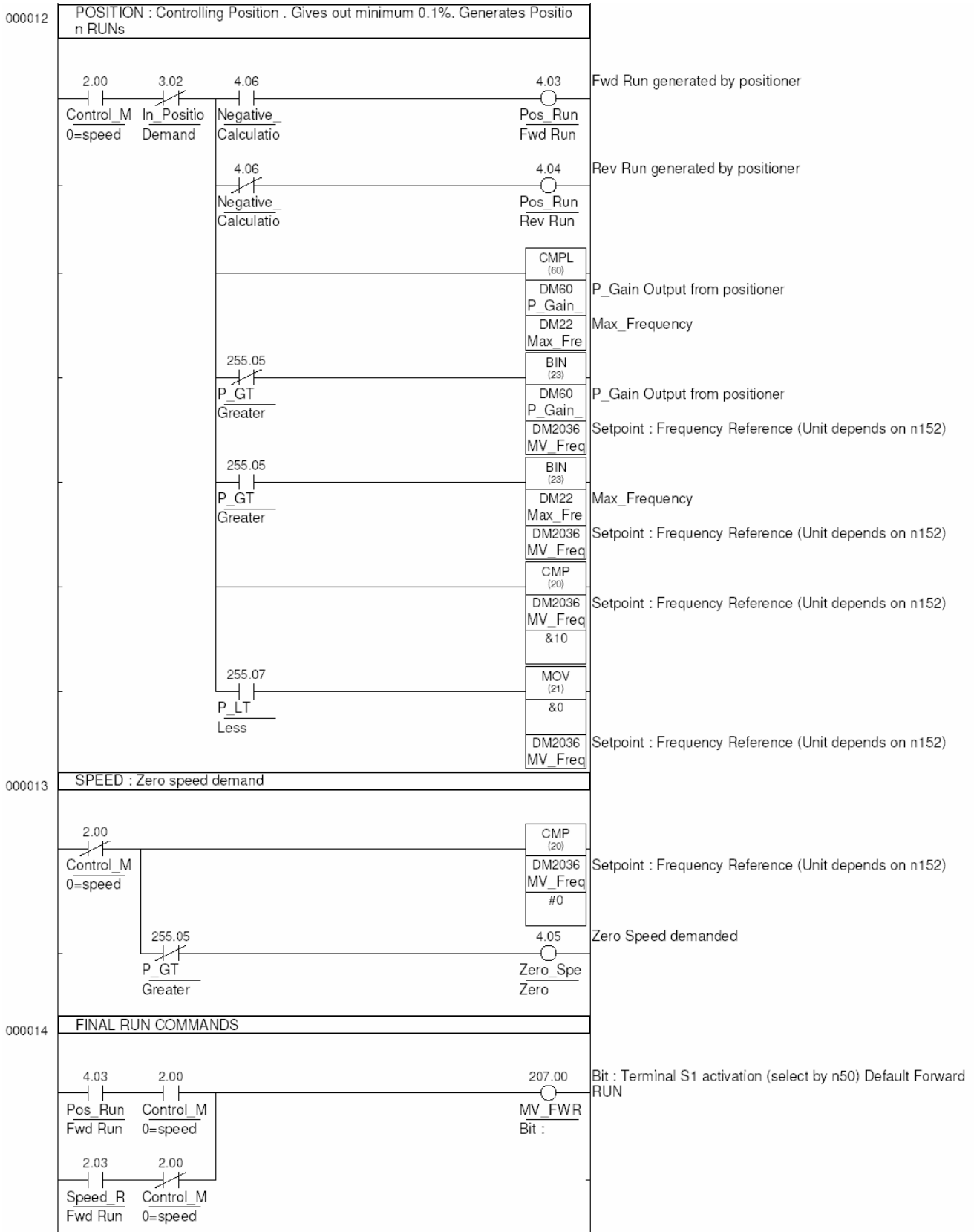

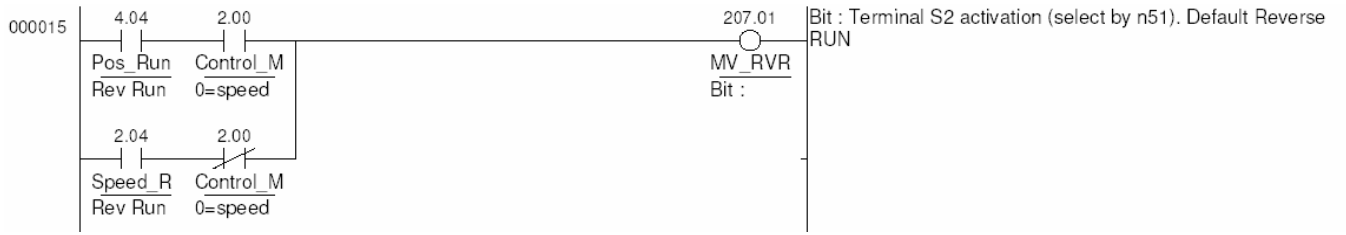

Pos\_Home\_Sequence

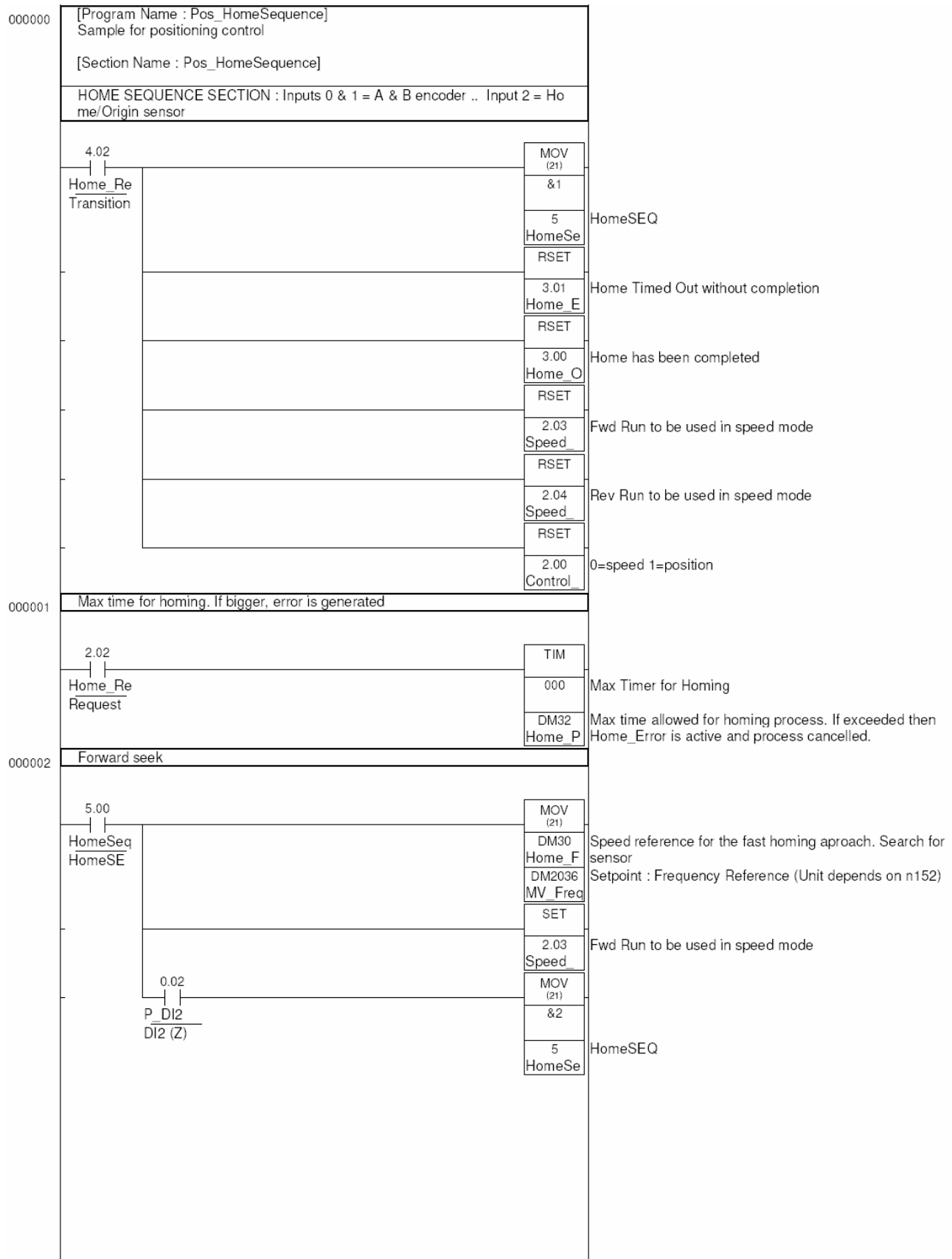

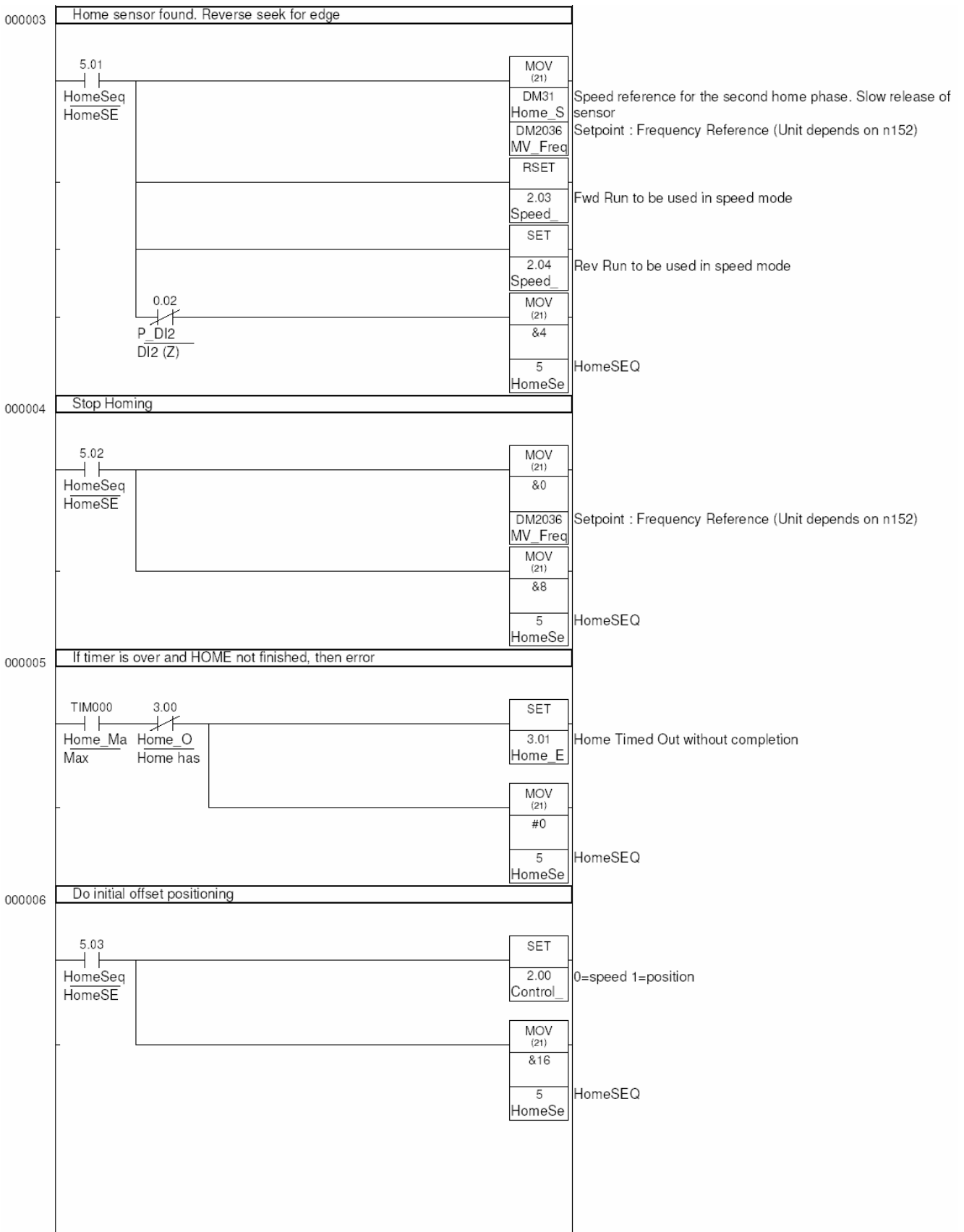

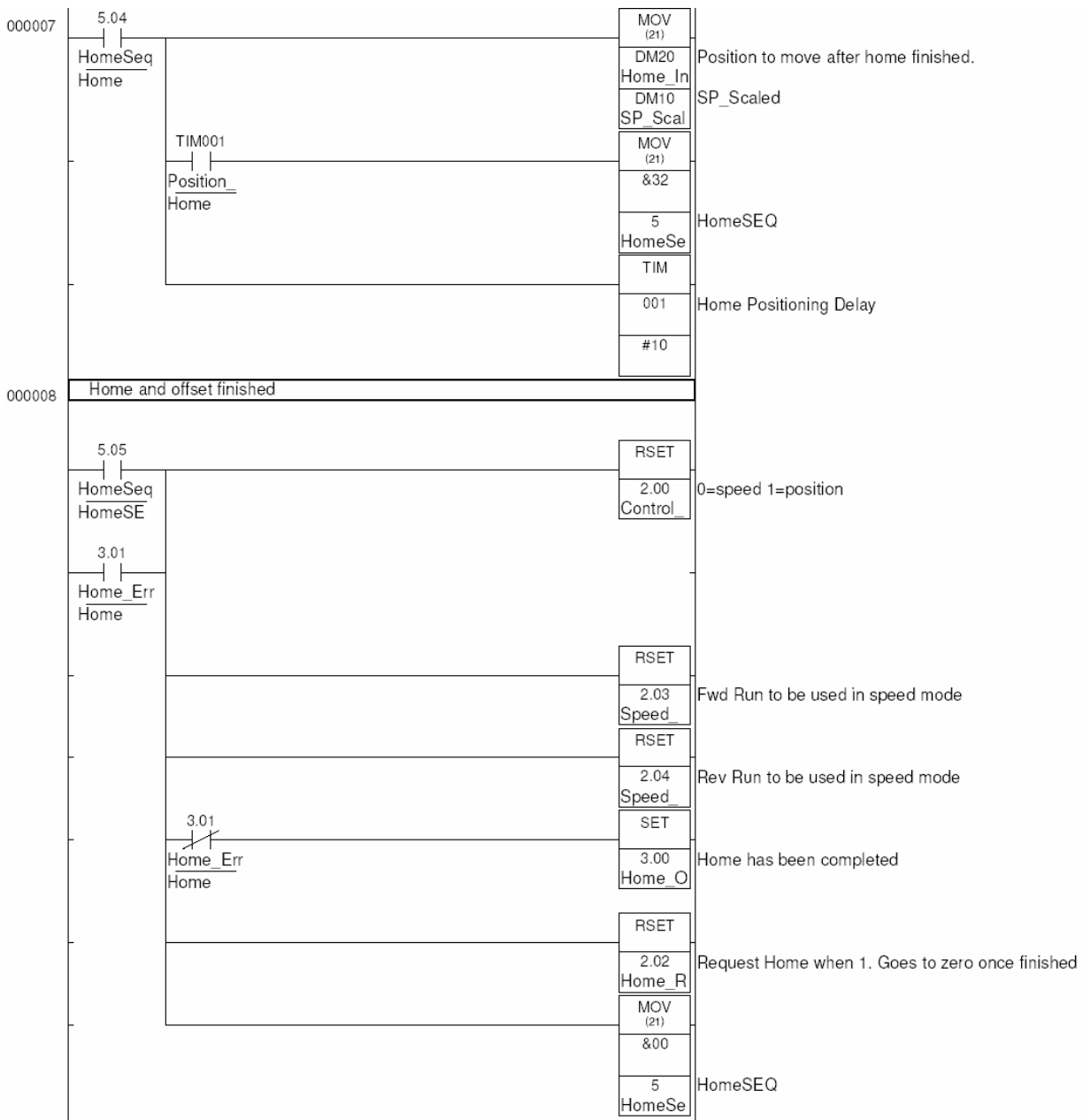

## Revision History

A manual revision code appears as a suffix to the catalog number on the front cover of the manual.

Cat. No. I01E-EN-01

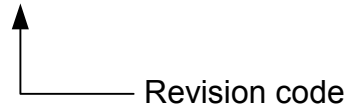

The following table outlines the changes made to the manual during each revision. Page numbers refer to the previous version.

Revision code	Date	Revised content
01	June 2003	Original production